

PERI kvalitātes prasības

DOMINO



Kontakti

PERI SIA
Betonēšanas veidņi
Tehniskie risinājumi
Sastatnes

Rudeņi 6, Salaspils nov., LV-2118, Latvija
info@peri-latvija.lv

Saturs	Lpp.	Izmaiņas	Datums Autors	Lpp.
Rāmis	2	Jaunā versija	10/2015 I fw	
Šarnīrveida stūris	12			
Starplika	15			
Atveidotājs	18			
Ārējais stūris	22			
Gala panelis DOMINO AT	24			
Piederumi	28			
Vārdnīca	35			

PERI kvalitātes prasības

DOMINO



Metāla rāmis	Nr.	Nosaukums	Artikula Nr.
--------------	-----	-----------	--------------

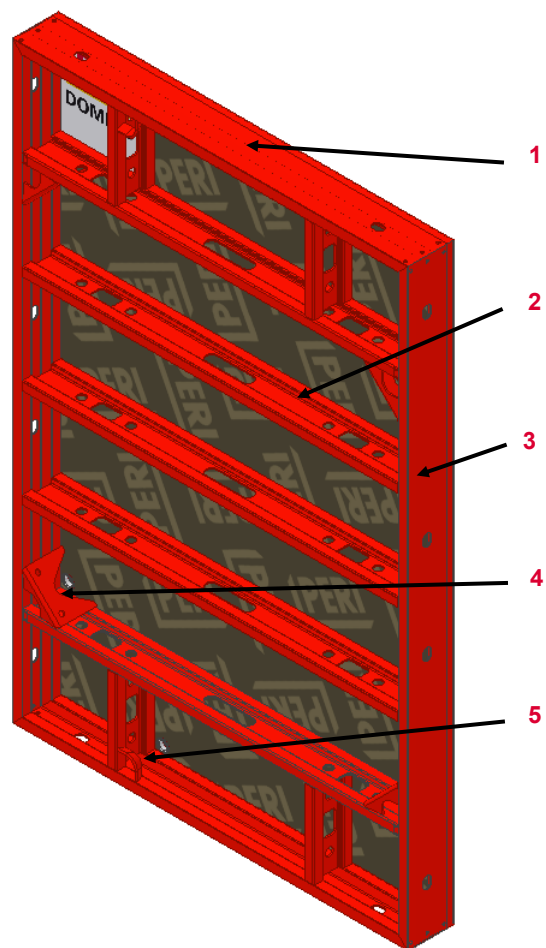

1	Gala profils	
2	Statnis	
3	Sānu profils	
4	Savilces enkurligzda	108556
5	Savilces enkurplātne	740473

PERI kvalitātes prasības

DOMINO



Nosaukums	Artikula Nr.
Panelis D 250x100	066020
Panelis D 250x75	066022
Panelis D 250x50	066025
Panelis D 250x35	125501
Panelis D 250x25	066026
Multipanelis DM 250x75	066024
Panelis D 150x100	124498
Panelis D 150x75	124504
Panelis D 150x50	124510
Panelis D 150x35	124517
Panelis D 150x25	124523
Multipanelis DM 150x75	124538

Nosaukums	Artikula Nr.
Panelis D 125x100	066040
Panelis D 125x75	066041
Panelis D 125x50	066043
Panelis D 125x35	125494
Panelis D 125x25	066044
Multipanelis DM125x75	066042
Panelis D 75x25	066064
Panelis D 75x35	125486
Panelis D 75x50	066063
Panelis D 75x75	066061
Panelis D 75x100	066060
Multipanelis DM 75x75	066062

PERI kvalitātes prasības

DOMINO



Alumīnija rāmis

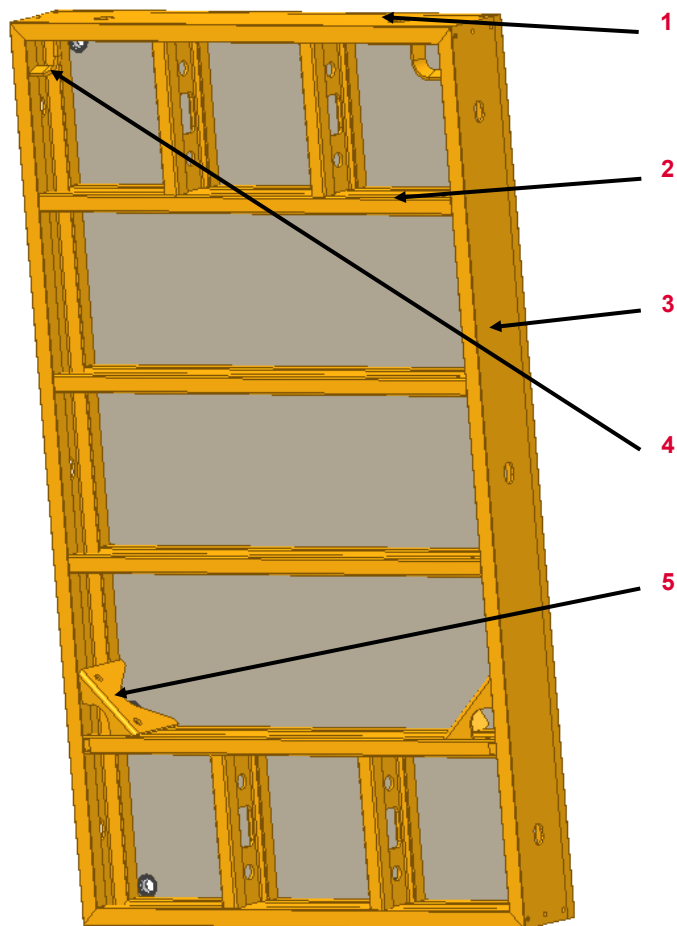

Nr.	Nosaukums	Artikula Nr.
1	Gala profils	
2	Statnis	
3	Gala profils	
4	Savilces Enkurplātne Alu	740474
5	Savilces enkurligzda Alu	108567

Nosaukums	Artikula Nr.
DA 125x 100	066050
DA 125x 75	066051
DA 250x 100	066021
DA 250x 75	066023

Metāla rāmis	Apraksts	Darbība	Izmaksas	Tips
--------------	----------	---------	----------	------

24.01 Saliekts rāmis

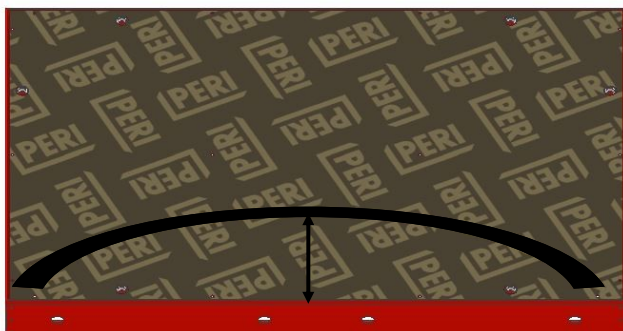

- > 8 mm



24.02 Panelis ir savērpts, kontrole, veicot mērīšanu pa diagonāli



- Starpība A un B > 5 mm



Metāla rāmis	Apraksts	Darbība	Izmaksas	Tips
--------------	----------	---------	----------	------



24.03 Iespiedums (bukte) rāmja profilā



Pēc taisnošanas jāveic metinājuma šuvju pārbaude



088244

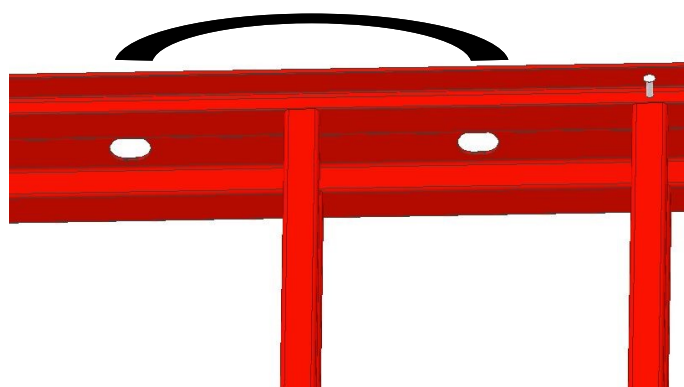

24.04 Deformēta rāmja profila sānu mala (šķautne)

■ ≤ 3 mm



■ > 3 mm



088244



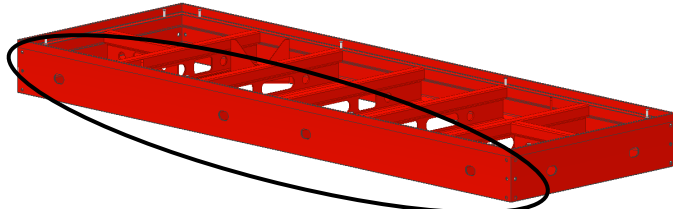











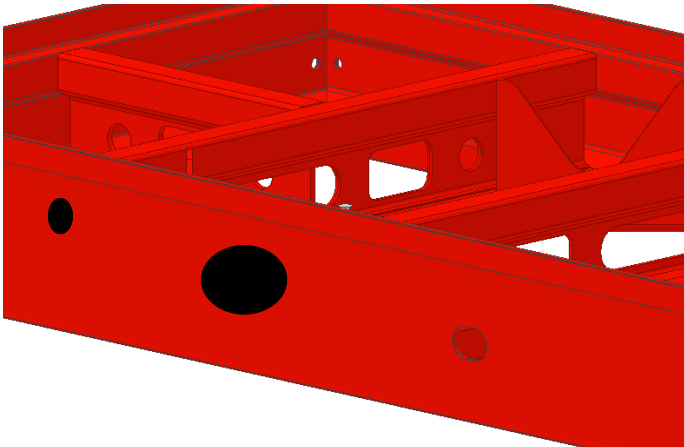

Metāla rāmis	Apraksts	Darbība	Izmaksas	Tips
	24.05 Deformēts gala profils <ul style="list-style-type: none">Nav iespējams izmantot DRS aizvietošanas stiprinājuma vietu			
	24.06 Deformēts rāmja sānu profils <ul style="list-style-type: none">Nav iespējams izmantot DRS aizvietošanas stiprinājuma vietu			

PERI kvalitātes prasības

DOMINO



Metāla rāmis	Apraksts	Darbība	Izmaksas	Tips	
	24.07 Statnis saliekts deformēts				
	<ul style="list-style-type: none"> ■ ≤ 3 mm 			088244	
	<ul style="list-style-type: none"> ■ > 3 mm ≤ 10 mm 				
	24.08 Savilces enkurplātne de- formēta trūkst				





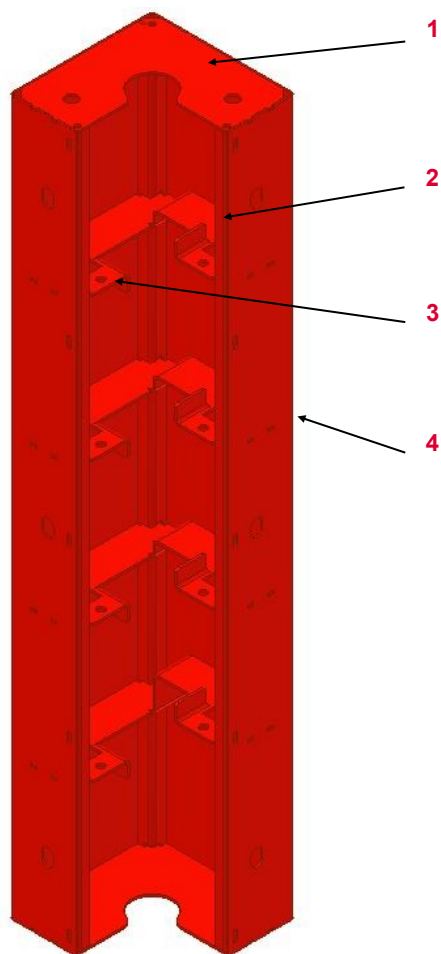





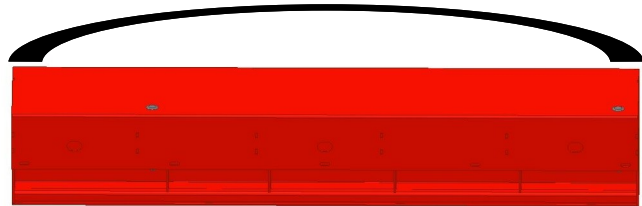

Metāla rāmis	Apraksts	Darbība	Izmaksas	Tips
	<p>24.09 Plīsusi metinājuma šuve uz rāmja stūra vai statņa</p>		 088028	
	<p>24.10 Caurums rāmja profilā</p>			
	<p>■ ≤ Ø 5 mm</p>		 088028	
	<p>■ > Ø 5 mm ≤ 15 mm</p>			
	<p>■ > 15 mm</p>			

Iekšējais metāla stūris DISE



Nr.	Nosaukums	Artikula Nr.
1	Nosegplāksne	
2	Profila mala	
3	Statnis	
4	Stūra virsma	

Nosaukums	Artikula Nr.
Iekšējais metāla stūris DISE 125	126280
Iekšējais metāla stūris DISE 150	126286
Iekšējais metāla stūris DISE 250	126242
Iekšējais metāla stūris DISE 75	126274

DISE	Apraksts	Darbība	Izmaksas	Tips
	24.11 Izliekta sutra virsma			
	24.12 Izliekts sutra profils			
	24.13 Bukte stūra virsmā			088027
	■ > 8 mm			
	■ > 3 mm			

PERI kvalitātes prasības

DOMINO



Šarnīrveida stūris DGE

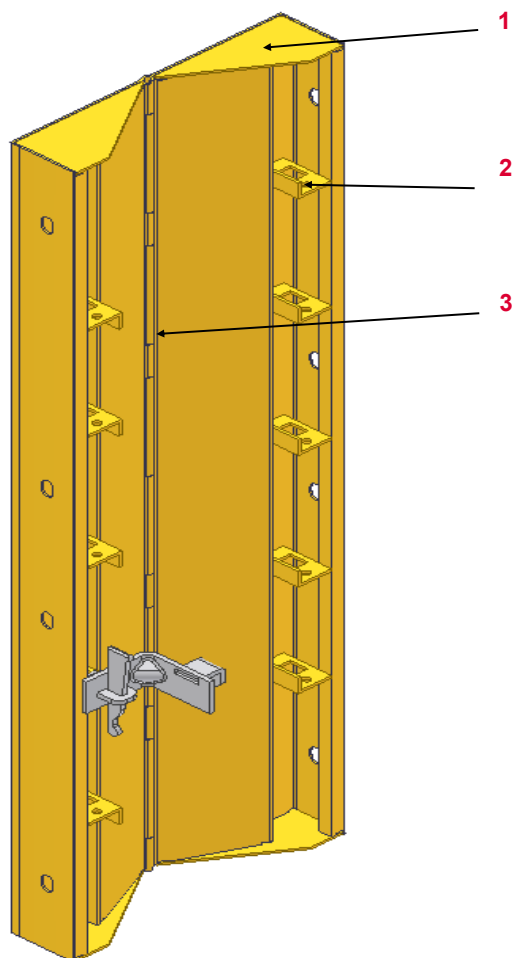

Nr.	Nosaukums	Artikula Nr.
1	Cover plate	750057
2	Corner	750058
3	Hinge	

Nosaukums	Artikula Nr.
Šarnīrveida stūris DGE 125	066047
Šarnīrveida stūris DGE 150	124605
Šarnīrveida stūris DGE 250	066029
Šarnīrveida stūris DGE 75	066067

Šarnīrveida stūris DGE	Apraksts	Darbība	Izmaksas	Tips
------------------------	----------	---------	----------	------



24.14 Saliiekts profils

- > 5 mm





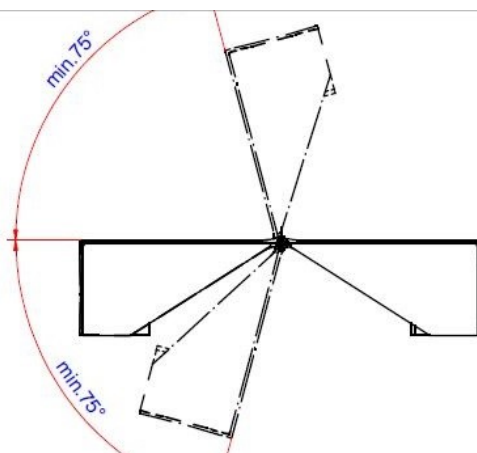











088244



24.15 Šarnīrveida stūris DGE ne-funkcionē

- Iztīrīt un ieeļļot enģi (viru)
- Ja nav iespējams atjaunot funkcionalitāti



Šarnīrveida stūris DGE	Apraksts	Darbība	Izmaksas	Tips
	<p>24.16 Deformēta, salauzta stūra noseģplāksne</p> <ul style="list-style-type: none"> ■ Ja iespējams ■ Vai, ja remonts nav iespējams 	 	 088027 	 
	<p>24.17 Deformēts savienojuma profils</p>			
	<p>24.18 Deformēta (bukvēta) šarnīrveida stūra darba virsma</p> <ul style="list-style-type: none"> ■ > 3 mm 		 088027	

PERI kvalitātes prasības

DOMINO





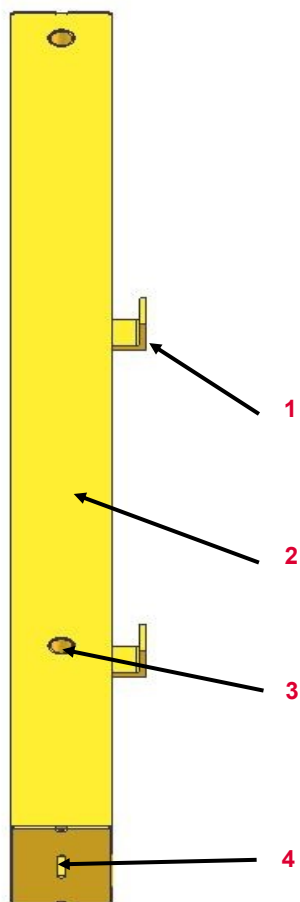





































Starplika

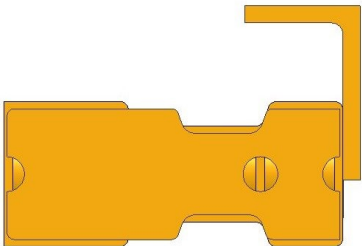

Nr.	Nosaukums	Artikula Nr.
1	Stūris Alu	770257
2	Darba virsma	
3	Caurule Alu	770258
4	Ieliskas plāksne	101959

Article	Article number
Starplika DWD 125x10	101964
Starplika DWD 125x5	066048
Starplika DWD 150/5	125944
Starplika DWD 150/10	125660
Starplika DWD 250x10	101986
Starplika DWD 250x5	066030
Starplika DWD 75x5	066068

Starplika	Apraksts	Darbība	Izmaksas	Tips
	24.19 Profils izliekts <ul style="list-style-type: none"> ■ > 8 mm 			
	24.20 Iespiedums (bukte) darba virsmā <ul style="list-style-type: none"> ■ > 3 mm ≤ 10 mm 			
	<ul style="list-style-type: none"> ■ Vai > 10 mm 			
	24.21 Deformēta noseglāksne <ul style="list-style-type: none"> ■ Nav bojāta metinājuma šuve 		 088244	
	<ul style="list-style-type: none"> ■ Vai ir bojāta metinājuma šuve 		 088250	
	24.22 Caurums profilā <ul style="list-style-type: none"> ■ ≤ 3 cm 			
	<ul style="list-style-type: none"> ■ > 3 cm 	 		

Starplika	Apraksts	Darbība	Izmaksas	Tips
	24.23 Salocīts stūris			
	<ul style="list-style-type: none"> ■ ≤ 10 mm ■ > 10 mm 	 	 088244  088258	 
	24.24 Nolauzts stūris		 088258	
	24.25 Caurule bojāta neizmantojama			

PERI kvalitātes prasības

DOMINO





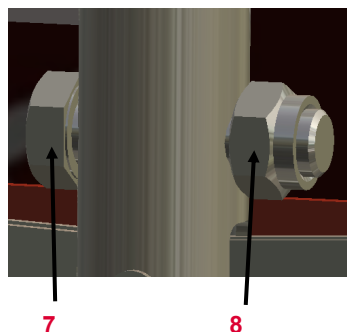
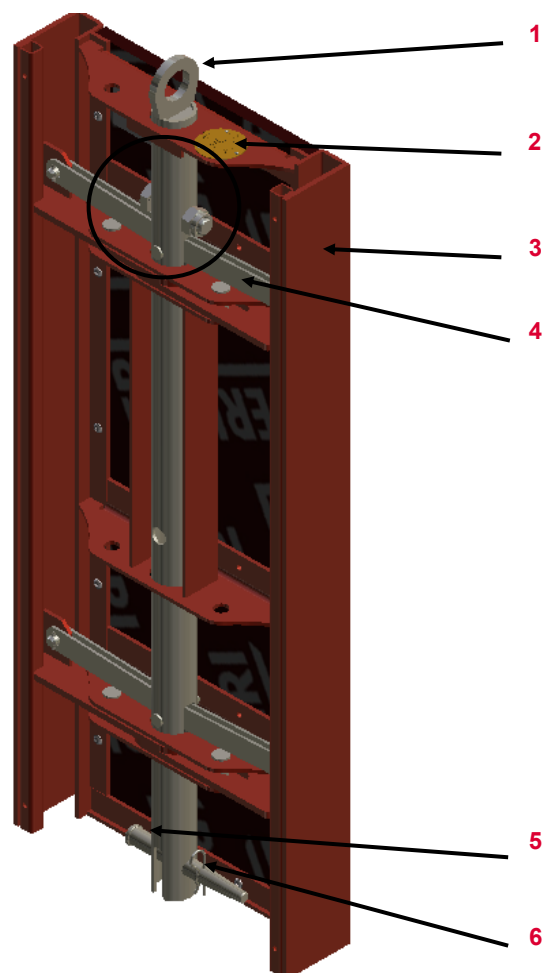









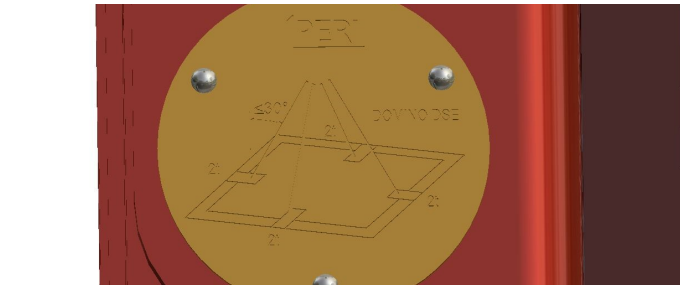

Atveidnotājs DSE

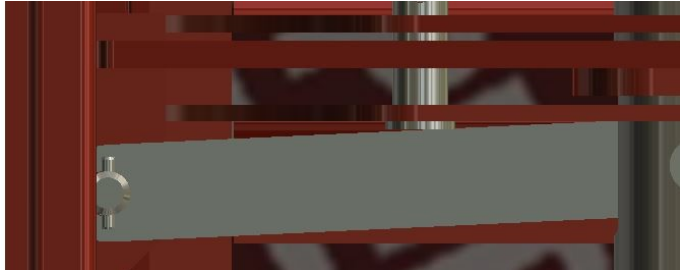

Nr.	Nosaukums	Artikula Nr.
1	Pacelšanas cilpa	111598
2	Marķējums	123488
3	Satvērējs	
4	Svira	111582
5	Tapa	111567
6	Kontrtapa	018060
7	Skrūve M24x 90	111571
8	Hex uzgrieznis M24	105032

Article	Article number
Atveidnotājs DSE 125	111655
Atveidnotājs DSE 275	111603
Atveidnotājs DSE 300	111617

Atveidnotājs DSE	Apraksts	Darbība	Izmaksas	Tips
	24.26 Pacelšanas cilpa			
	<ul style="list-style-type: none"> <li data-bbox="853 571 1279 635">■ Salocīta 	 088244 		
	24.27 Marķējums nesalasāms trūkst			
		123488		
	24.28 Svira			
	<ul style="list-style-type: none"> <li data-bbox="853 1262 1279 1326">■ Salocīta 	 088244 		

Atveidnotājs DSE	Apraksts	Darbība	Izmaksas	Tips
------------------	----------	---------	----------	------

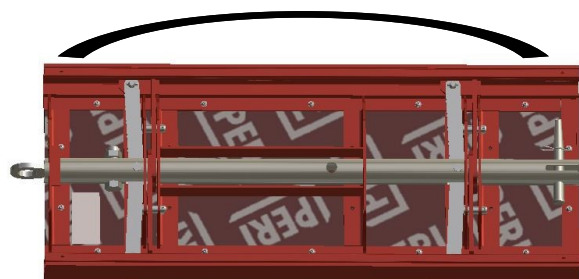

24.29 Satvērējs saliekts



088244

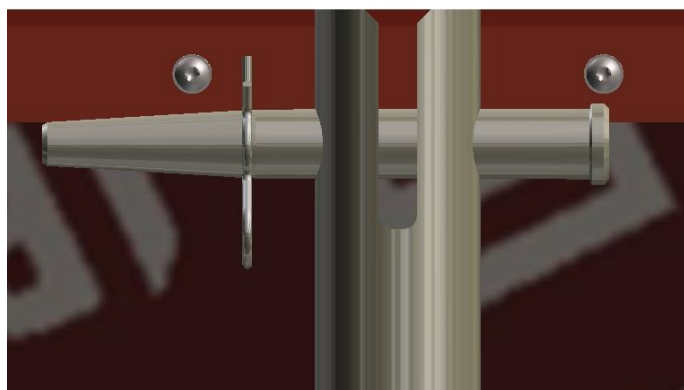

24.30 Tapa trūkst



111567 (Tapa)
018060 (Kontrtapa)



Vārpstas atveidoņtājs DSE (111665)	Nr.	Nosaukums	Artikula Nr.
------------------------------------	-----	-----------	--------------

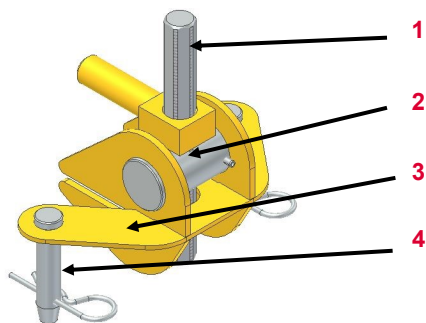

1	Vārpsta	111658
2	Vītnes skrūve	111664
3	Satvere	
4	Skrūve	105822

Damage	Apraksts	Darbība	Izmaksas	Tips
--------	----------	---------	----------	------

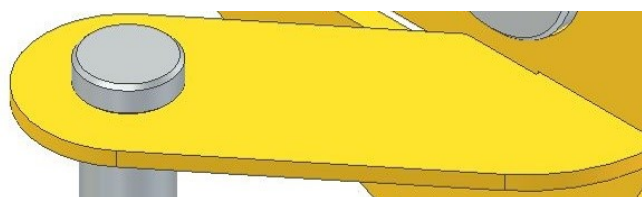

24.31 Saliekta satvere



088244

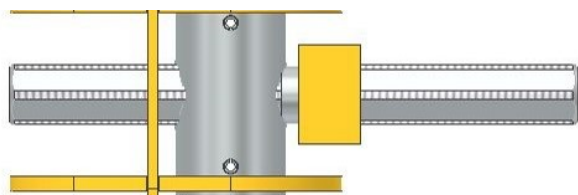

24.32 Vārpsta | vītnes skrūve vairs nesader

■ Ja iespējams



■ Vai ja nav iespējams



088289





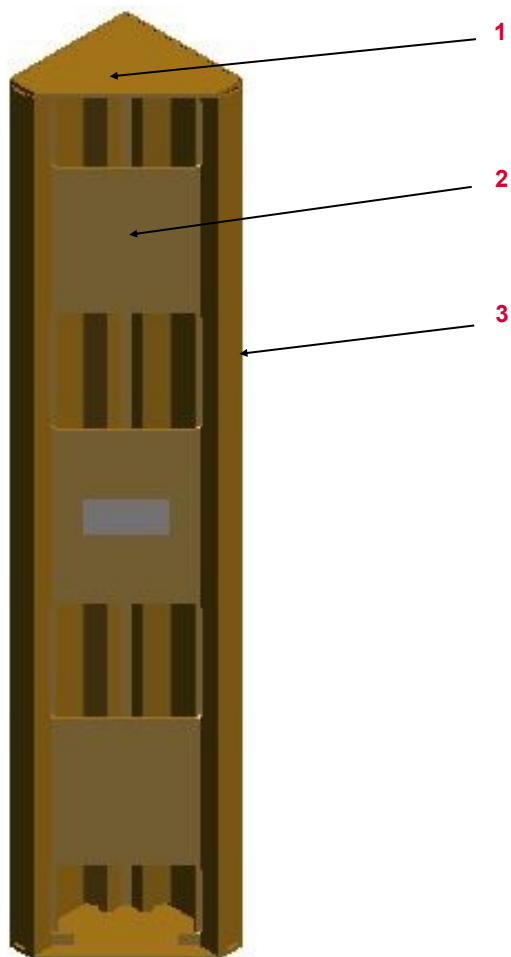









Ārējais stūris DAW



Nr.	Nosaukums	Artikula Nr.
1	Nosekplāksne	
2	Plāksne	
3	Darba virsma	

Nosaukums	Artikula Nr.
Ārējais stūris DAW 75	066066
Ārējais stūris DAW 125	066046
Ārējais stūris DAW 150	124608
Ārējais stūris DAW 250	066028

Ārējais stūris DAW	Apraksts	Darbība	Izmaksas	Tips
	<p>24.33 Bukte darba virsmā</p> <p>■ > 3 mm</p>		 088244	
	<p>24.34 Bojāta plāksne</p>			
	<p>24.35 Deformēta noseglāksne</p>		 088250	

PERI kvalitātes prasības

DOMINO



Gala panelis DOMINO AT

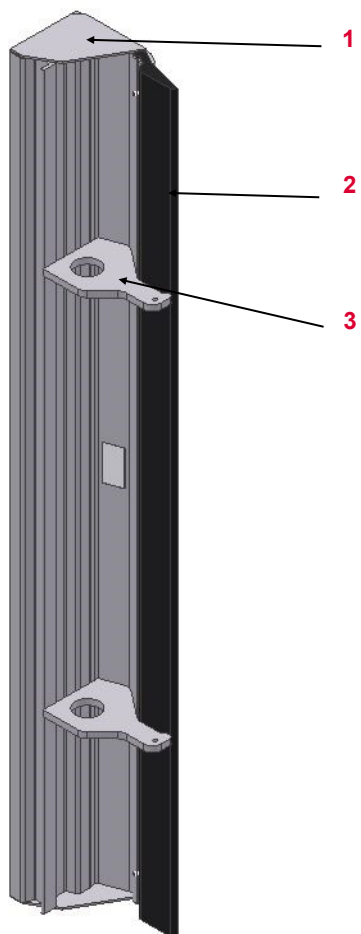

Nr.	Nosaukums	Artikula Nr.
1	Nosegplāksne	725011
2	Blīvējošais profils	
3	Āķis	100781

Article	Article number
Gala panelis DOMINO AT 125x3	101934
Gala panelis DOMINO AT 125x5	108856
Gala panelis DOMINO AT 205x3	101927
Gala panelis DOMINO AT 205x5	108855
Gala panelis DOMINO AT 275x3	106203
Gala panelis DOMINO AT 275x5	108857

PERI kvalitātes prasības

DOMINO



Gala panelis AT	Apraksts	Darbība	Izmaksas	Tips	
	<p>24.36 Bīvējošais profils bojāts ieplēsts</p> <ul style="list-style-type: none"> ■ > 3 mm dziļumā 				
	<p>24.37 Āķis bojāts trūkst</p>			<p>088154</p>	
	<p>24.38 Profils izliekts</p> <ul style="list-style-type: none"> ■ > 8 mm 				
	<p>24.39 Nosegplāksne bojāta</p> <ul style="list-style-type: none"> ■ > 3 mm līdz ≤10 mm ■ Vai > 10 mm 			<p>088244</p>	
				<p>088250</p>	

PERI kvalitātes prasības

DOMINO



Gala panelis DOMINO MTF

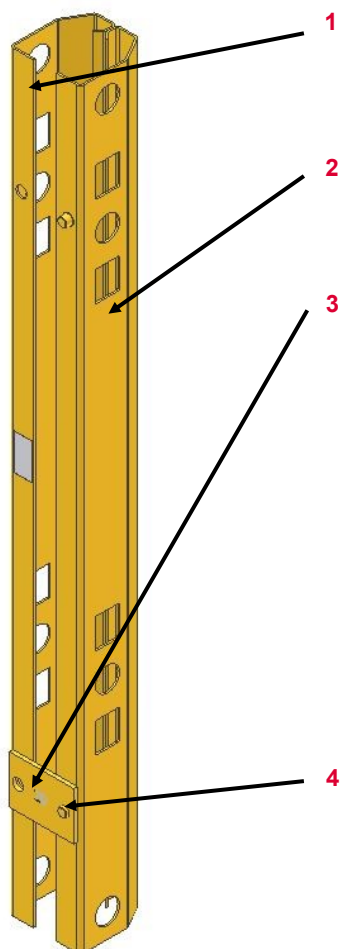

Nr.	Nosaukums	Artikula Nr.
1	Vidus daļa labā	725011
2	Vidus daļa kreisā	
3	Plāksne 20	101804
4	Skrūves	101215

Article	Article number
Gala panelis DOMINO MTF 125 x 20	101935
Gala panelis DOMINO MTF 125 x 24/25	101936
Gala panelis DOMINO MTF 125 x 30	101937
Gala panelis DOMINO MTF 125 x 35/36	101940
Gala panelis DOMINO MTF 250 x 20	101928
Gala panelis DOMINO MTF 250 x 24/25	101929
Gala panelis DOMINO MTF 250 x 30	101930
Gala panelis DOMINO MTF 250 x 35/36	101931

Gala panelis MTF	Apraksts	Darbība	Izmaksas	Tips
------------------	----------	---------	----------	------

24.40 Profils deformēts | salocīts

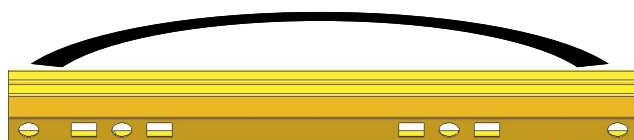

■ > 8 mm



24.41 Plāksne salocīta | nelietojama

















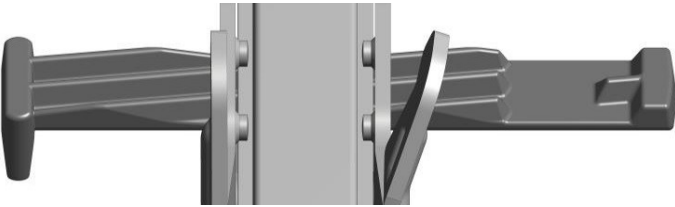

088166

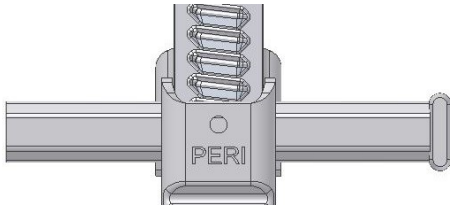

PERI kvalitātes prasības

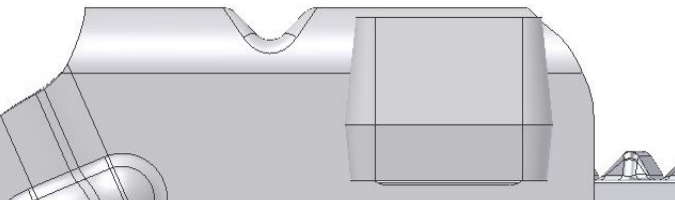
DOMINO



DRS DOMINO stiprinājums (066080)	Apraksts	Darbība	Izmaksas	Tips
	24.42 Stiprinājums izjucis		 088031	
	24.43 Fiksators salocīts		 088032	
	24.44 Ķīlis nekustas			
	24.45 Sitamā virsma salauzta			

PERI kvalitātes prasības

DOMINO



Ķīlis DKS (066081)	Nr.	Nosaukums	Artikula Nr.
--------------------	-----	-----------	--------------

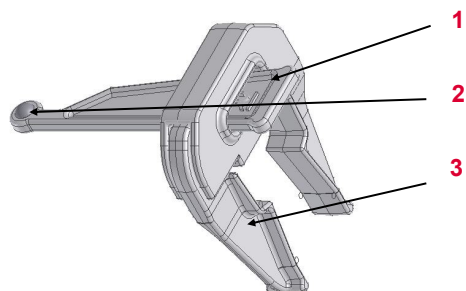

1	Ķīlis	100703
2	Atdure	107521
3	Fiksators	

Damage	Apraksts	Darbība	Izmaksas	Tips
--------	----------	---------	----------	------

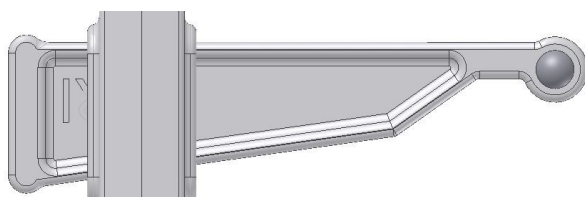

24.46 Ķīlis trūkst



088260

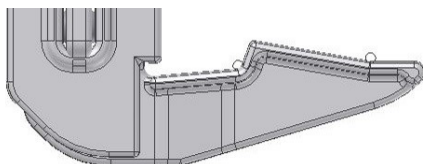

24.47 Fiksators saliekts



088244



DOMINO rīgelis DAR 80 (066084)	Nr.	Nosaukums	Artikula Nr.
--------------------------------	-----	-----------	--------------

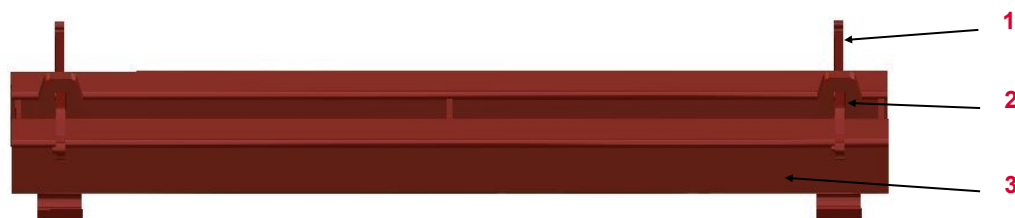

1	Ķīlis	723318
2	Vadīkla	723321
3	Profils	

Damage	Apraksts	Darbība	Izmaksas	Tips
--------	----------	---------	----------	------

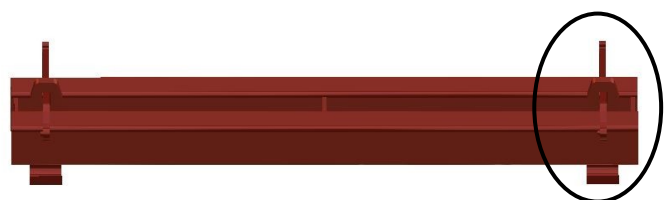

24.48 Vadīkla vai ķīlis defektīvs | trūkst



088259

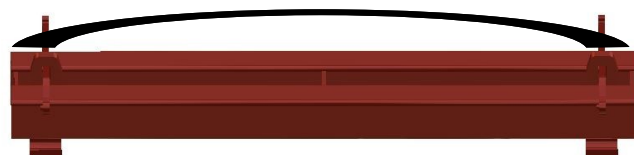

24.49 Profils izliekts

■ > 8 mm



Betonēšanas konsole DG 85 (066085)	Apraksts	Darbība	Izmaksas	Tips
	24.50 Iepilīsis metinājums <ul style="list-style-type: none"> ■ Deformācija ■ Vai bez deformācijas 	 	 	 
	24.51 Āķis saliekts		 088244	
	24.52 Vertikālā caurule deformēta <ul style="list-style-type: none"> ■ Ja iespējams ■ Vai ja nav iespējams 	 	 088244 	 
	24.53 Deformēta detaļa		 088244	

PERI kvalitātes prasības

DOMINO



Aisargmargas staba turētājs DOMINO (106877)	Nr.	Nosaukums	Artikula Nr.
---	-----	-----------	--------------

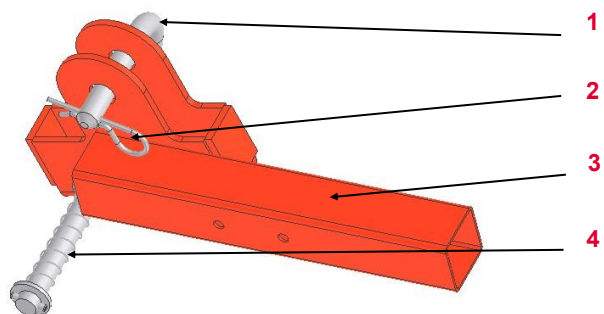

1	Tapa	721814
2	Kontrtapa	018060
3	Turētājs	
4	Atspere	721816

Damage	Apraksts	Darbība	Izmaksas	Tips
--------	----------	---------	----------	------

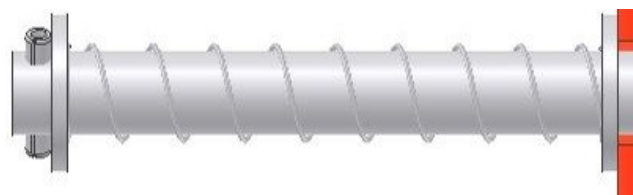

24.54 Atspere trūkst

 721816 (Atspere)
711074 (Paplāksne)
710912 (Tapa)

 088264

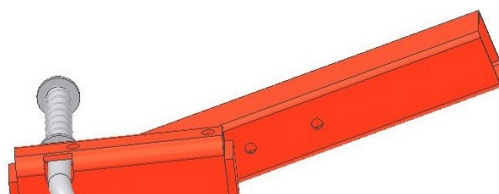









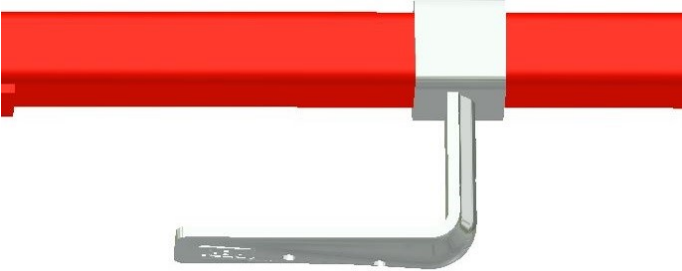



24.55 Detaļa saliekta



 088244













HSGP-2 (116292)	Apraksts	Darbība	Izmaksas	Tips
	24.56 Āķis deformēts trūkst	 115673	 088227	
	24.57 Kronšteins salauzts		 088229	
	24.58 Izliekums			

PERI kvalitātes prasības

DOMINO



















DOMINO kraušanas ierīce (066094)	Apraksts	Darbība	Izmaksas	Tips
	<p>24.59 Plaisa metinājuma šuvē</p> <ul style="list-style-type: none"> ■ Mehānisks bojājums (Kraušanas ierīce salocīta) ■ Vai cits bojājums (ne mehāniska spēka iedarbības ietekmē) 	<ul style="list-style-type: none">   	<ul style="list-style-type: none">   	<ul style="list-style-type: none">  
	<p>24.60 Marķējuma plāksne nesalasāma pazudusi</p>	<ul style="list-style-type: none">  750059 (Marķējuma plāksne) 710217 (Kniede) 	<ul style="list-style-type: none">  	<ul style="list-style-type: none"> 

PERI kvalitātes prasības

Vārdnīca



Ikona	Nozīme	Ikona	Nozīme	Ikona	Nozīme
	Nav derīgs - materiāls jānoraksta		Jāizraksta rēķins (klientam)		Vizuāls bojājums
	Derīgs - materiāls paliek nomas parkā		Rēķins nav jāizraksta		Funkcionāls bojājums
	Norakstāms materiāls – izdošana nomā nav pieļaujama dēļ neatbilstības drošības prasībām		Saīsināt materiālu		Funkcionāls bojājums - izdošana nomā nav pieļaujama
	Remonts saskaņā ar instrukciju		Marķēt materiālu		Statisks bojājums - izdošana nomā nav pieļaujama
	Aukstā labošana – veicot metinājuma šuvju un blakus detaļu pēcpārbaudi		Nomainīt bojāto materiālu		
	Remonts tikai pēc izmaksu tāmes izvērtēšanas		Atvietot trūkstošo materiālu		
	Materiāla tīrīšana				