

PERI kvalitātes prasības

ST 100 saliekamais tornis



Kontakti

PERI SIA
Betonēšanas veidņi
Tehniskie risinājumi
Sastatnes

Rudeņi 6, Salaspils nov., LV-2118, Latvija
info@peri-latvija.lv

Saturs	Lpp.
Rāmis ST 100	2
Diagonāle ST 100	4
ST 100 galva (lielā)	5
ST 100 pēda	7
ST 100 galva (mazā)	8
Marga	9
Transportation Wheel UEW	15
Connection Transportation Wheel	16
Vārdnīca	18

Izmaiņas	Datums Autors	Lpp.
Jaunā versija	03/2016 fw	
Vairāki attēli pievienoti	05/2018 fw	

PERI kvalitātes prasības

ST 100 saliekamais tornis



Pamatnes rāmis, rāmis; gala rāmis

Nr.	Nosaukums	Artikula Nr.
-----	-----------	--------------

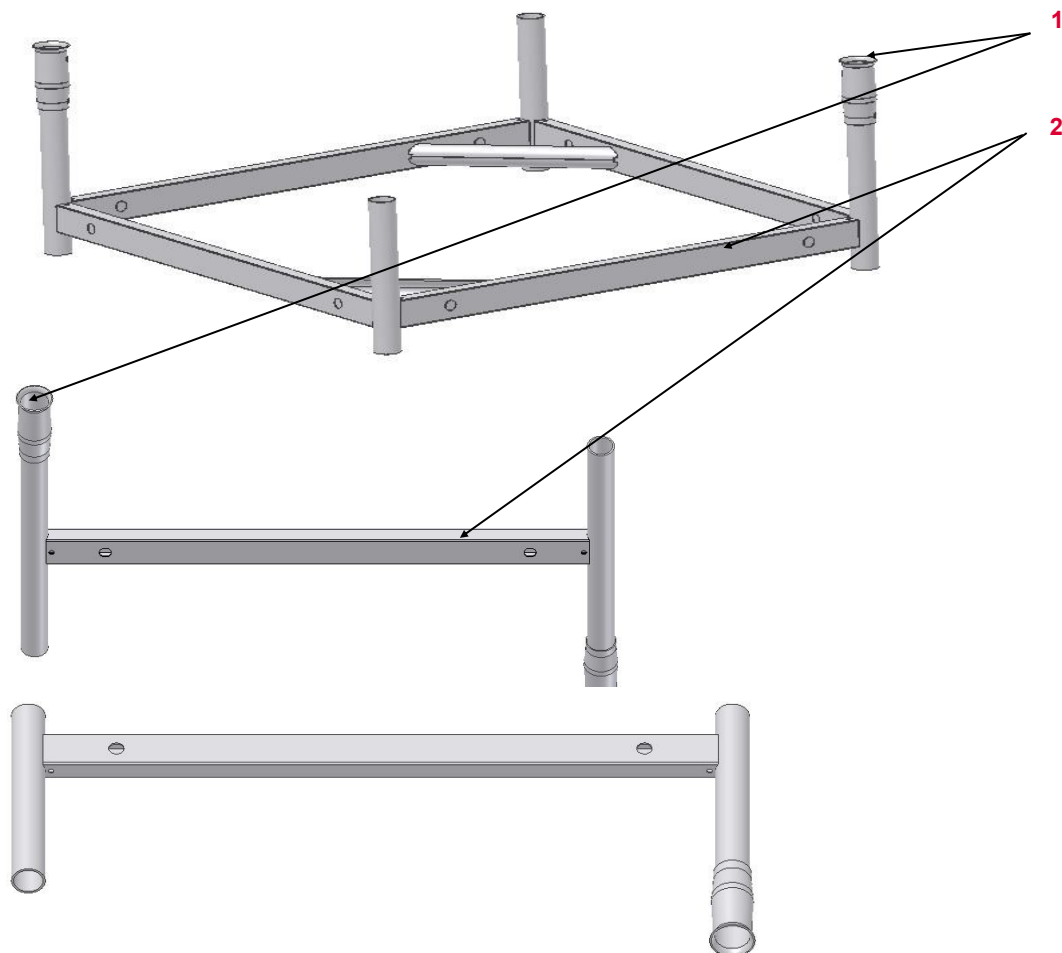

1	Caurules savienojums
---	----------------------

2	Rāmis
---	-------

Attiecināms uz

Artikula Nr.

Pamatnes rāmis ST 100 verz.

019900

Rāmis ST 100 verz.

019910































Gala rāmis ST 100 verz.

019930

PERI kvalitātes prasības

ST 100 saliekamais tornis















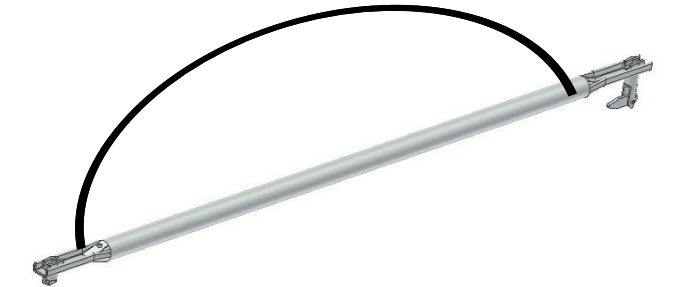







Rāmis	Apraksts	Darbība	Izmaksas	Tips
	16.01 Rāmis iespiedumg bukte <ul style="list-style-type: none"> ■ $D \leq 10$ mm ■ Vai $d > 10$ mm ■ Vai skarta šķautne 	     	  	  
	16.02 Deformēts savienojums <ul style="list-style-type: none"> ■ ≤ 10 mm ■ Vai > 10 mm 	  	 088244 	 
	16.03 Plaisa savienojuma kausa caurulē <ul style="list-style-type: none"> ■ Plaisa, kas radusies deformācijas rezultātā (nepareiza lietošana) ■ Vai bez redzamas deformācijas 	   	 	 

PERI kvalitātes prasības

ST 100 saliekamais tornis



Diagonāle ST 100 (019940)	Apraksts	Darbība	Izmaksas	Tips
	16.04 Profils saliekts iztrūkst	 710123 (Mēlīte) 710910 (Kniede)	 088391 089042	
	16.05 Saliekta diagonāle		 088244	
	<ul style="list-style-type: none"> ■ ≤ 3 mm 	 		
	<ul style="list-style-type: none"> ■ Vai > 3 mm (L/500) 			
	16.06 Deformēts savienojums		 088244	
	<ul style="list-style-type: none"> ■ ≤ 5 mm 	 		
	<ul style="list-style-type: none"> ■ Vai > 5 mm 			

PERI kvalitātes prasības

ST 100 saliekamais tornis



Galva lielā (019950)	Apraksts	Darbība	Izmaksas	Tips
	16.07 Rags	<ul style="list-style-type: none"> ■ Saliects, bet metināšanas šuve nav bojāta 	088395	
	<ul style="list-style-type: none"> ■ Vai bojāta metināšanas šuve 		088394	
	<ul style="list-style-type: none"> ■ Vai iztrūkst 		088394	
	16.08 Deformēta pamata plātne	<ul style="list-style-type: none"> ■ > 5 mm 		

PERI kvalitātes prasības

ST 100 saliekamais tornis



Galva mazā(019950)	Apraksts	Darbība	Izmaksas	Tips
--------------------	----------	---------	----------	------



16.09 Saliekta vītne

















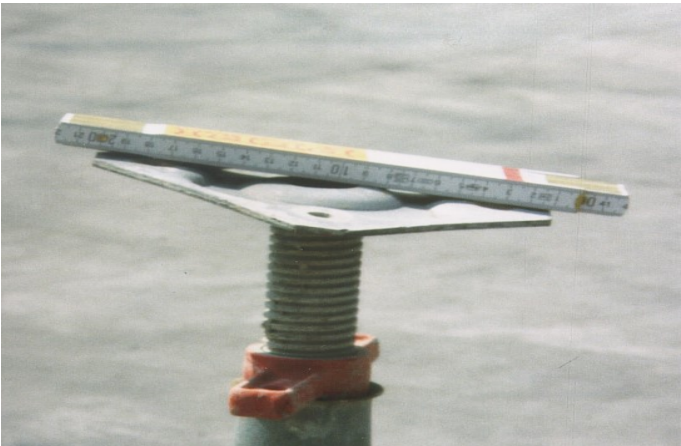

16.10 Uzgrieznis bojāts | trūkst



PERI kvalitātes prasības

ST 100 saliekamais tornis



Pēda vītne TR 38-70/50 (019780)	Apraksts	Darbība	Izmaksas	Tips
	16.11 Spārnuzgrieznis salauzts	 		
	16.12 Pamata plātne <ul style="list-style-type: none"> ■ Saliekta (vītne nav skarta) ■ Vai saliekta un vītne skarta ■ Vai plaisa metinājuma šuvē 	<ul style="list-style-type: none">      	<ul style="list-style-type: none">  088244   	<ul style="list-style-type: none">   

PERI kvalitātes prasības

ST 100 saliekamais tornis



Augšējās plātnes vītne (319790; 116081)	Apraksts	Darbība	Izmaksas	Tips
	16.13 Spārnuzgrieznis salauzts			
	16.14 Spīles saliekta			088244
	16.15 Vītne saliekta			

PERI kvalitātes prasības

ST 100 saliekamais tornis



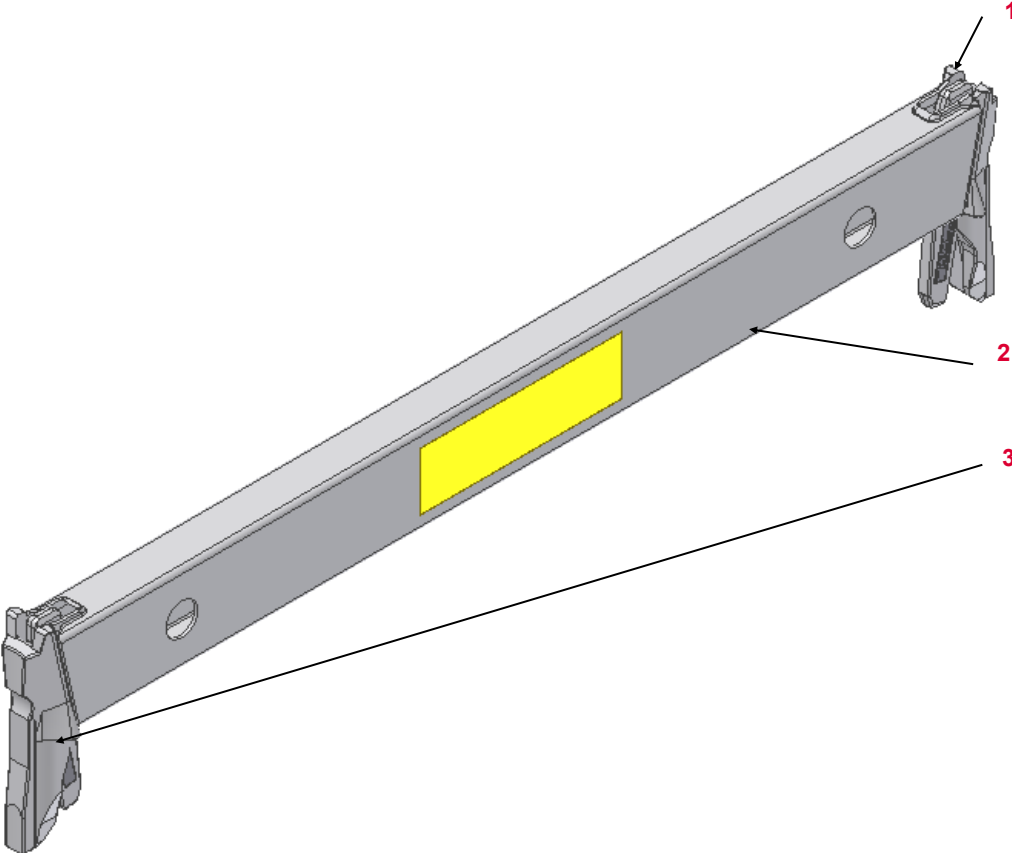







Marga UH	Nr.	Nosaukums	Artikula Nr.
	1	Ķīlis	100109
	2	Marga	
	3	Margas uzgalis	100018
Attiecināms uz			Artikula Nr.
Marga UH 72			100440
Marga UH 104			100192
Marga UH 150			100021
Marga UH 200			100023
Marga UH 250			100025
Marga UH 300			100027
Marga UH 400			100029
Marga UH 75			100017
Marga UH 100			101159

PERI kvalitātes prasības

ST 100 saliekamais tornis



Marga UH	Apraksts	Darbība	Izmaksas	Tips
	16.16 Profilā iespiedums bukte			
	16.17 Plaša margas atvērumā iztrūkst ķīlis			

PERI kvalitātes prasības

ST 100 saliekamais tornis



Marga UH	Apraksts	Darbība	Izmaksas	Tips
----------	----------	---------	----------	------

16.18 Deformēta katns



PERI kvalitātes prasības

ST 100 saliekamais tornis



Marga UH	Apraksts	Darbība	Izmaksas	Tips
	16.19 Bukte ķīļa apvidū	<ul style="list-style-type: none"> ■ Ja iespējams 	088244	
	<ul style="list-style-type: none"> ■ Vai ja nav iespējams 			
	<ul style="list-style-type: none"> ■ Vai plaisa materiālā 			
	16.20 Bukte caurumā	<ul style="list-style-type: none"> ■ Ja cauruma ģeometrija nav ietekmēta 	088244	
	<ul style="list-style-type: none"> ■ Vai ja ir ietekmēta 			
	<ul style="list-style-type: none"> ■ Vai ja ir radusies plaisa 			

PERI kvalitātes prasības

ST 100 saliekamais tornis



Marga UH	Apraksts	Darbība	Izmaksas	Tips
----------	----------	---------	----------	------

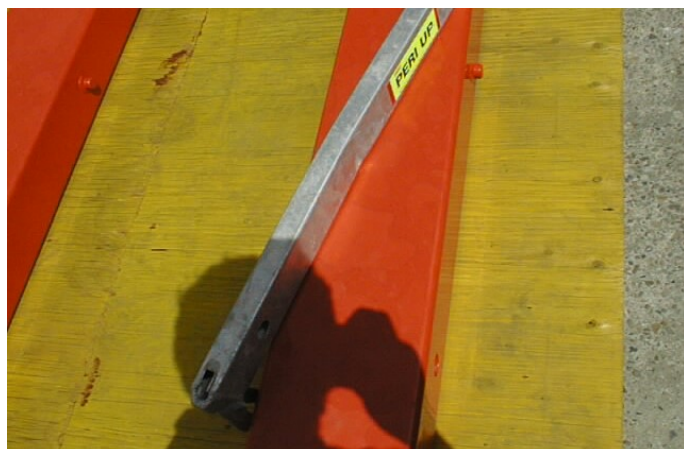

16.21 Horizontāls izliekums

- Kantis nav bojātas
- $Un \leq$ pieļaujamais izliekums (L/300)



- Vai $>$ pieļaujamais izliekums



Element	Perm. bent
Marga UH 25	≤ 3 mm
Marga UH 50	≤ 3 mm
Marga UH 75	≤ 3 mm
Marga UH 100	≤ 3 mm
Marga UH 125	≤ 4 mm
Marga UH 150	≤ 5 mm
Marga UH 200	≤ 7 mm
Marga UH 250	≤ 8 mm
Marga UH 300	≤ 10 mm

PERI kvalitātes prasības

ST 100 saliekamais tornis





















Marga UH	Apraksts	Darbība	Izmaksas	Tips
	16.22 Vertikāls izliekums	 		

PERI kvalitātes prasības

ST 100 saliekamais tornis



Transportēšanas ritenis UEW (116176)	Apraksts	Darbība	Izmaksas	Tips
	<p>16.23 Ritenis</p> <ul style="list-style-type: none"> ■ Sabojāts pārslodzes dēļ ■ Vai nolietojies 	 	 	 
	<p>16.24 Caurule</p> <ul style="list-style-type: none"> ■ Bukte ■ Vai izrauti caurumi 	 	 	 
	<p>16.25 Bojāta pretsiniena aizsardzība</p>			

PERI kvalitātes prasības

ST 100 saliekamais tornis



Transportēšanas riteņa savienojums ST 100 (116800)

Nr. Nosaukums Artikula Nr.

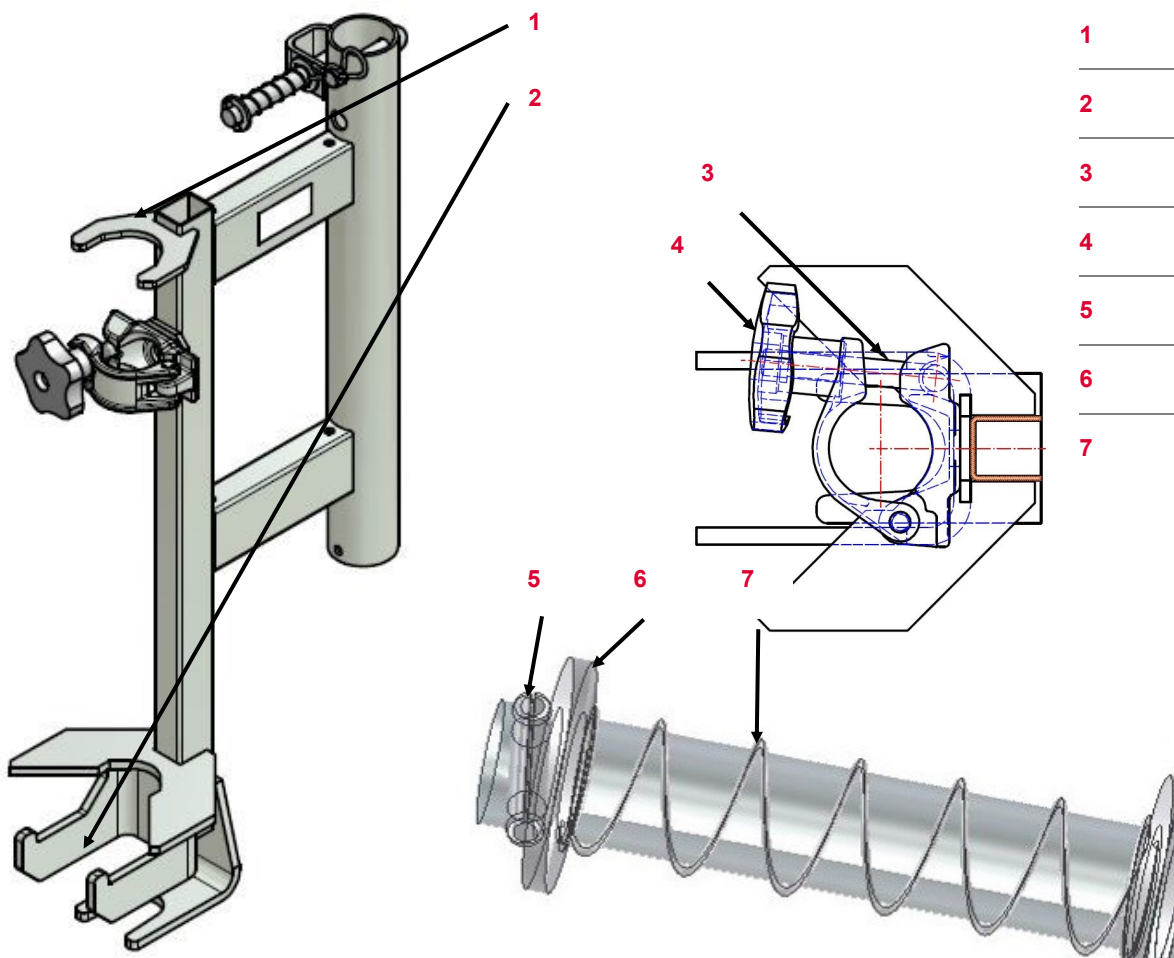

1	Augšējā vadula	
2	Apakšējā vadula	
3	Skrūve	710702
4	Rokturis	117388
5	Kniede	721925
6	Paplāksne	711043
7	Atspere	116177

PERI kvalitātes prasības

ST 100 saliekamais tornis



Transportēšanas riteņa savienojums ST 100	Apraksts	Darbība	Izmaksas	Tips
---	----------	---------	----------	------

16.26 Bojāta atspere

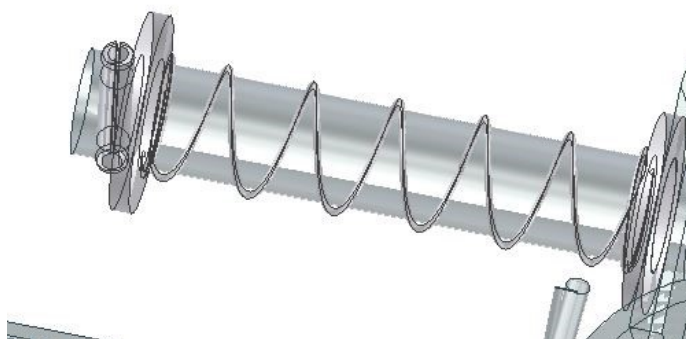

16.27 Saliekti kronšteini





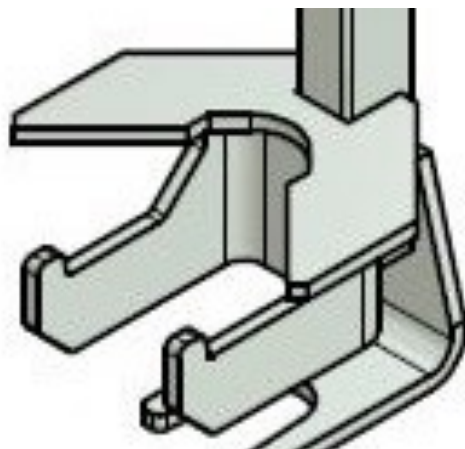













088244



PERI kvalitātes prasības

Vārdnīca



Ikona	Nozīme	Ikona	Nozīme	Ikona	Nozīme
	Nav derīgs - materiāls jānoraksta		Jāizraksta rēķins (klientam)		Vizuāls bojājums
	Derīgs - materiāls paliek nomas parkā		Rēķins nav jāizraksta		Funkcionāls bojājums
	Norakstāms materiāls – izdošana nomā nav pieļaujama dēļ neatbilstības drošības prasībām		Saīsināt materiālu		Funkcionāls bojājums - izdošana nomā nav pieļaujama
	Remonts saskaņā ar instrukciju		Marķēt materiālu		Statisks bojājums - izdošana nomā nav pieļaujama
	Aukstā labošana – veicot metinājuma šuvju un blakus detaļu pēcpārbaudi		Nomainīt bojāto materiālu		
	Remonts tikai pēc izmaksu tāmes izvērtēšanas		Atvietot trūkstošo materiālu		
	Materiāla tīrīšana				