

PERI kvalitātes prasības

PEP stutes



Kontakti

PERI SIA
Betonēšanas veidņi
Tehniskie risinājumi
Sastatnes

Rudeņi 6, Salaspils nov., LV-2118, Latvija
info@peri-latvija.lv

Saturs	Lpp.
PEP Ergo	2
PEP 20, 30	8
Piederumi	13
Vārdnīca	26

Izmaiņas	Datums Autors	Lpp.
Jaunā versija	09/2015 fw	
20.07.24 parametru izmaiņas	06/2016 fw	
Pievienotas vairāki attēli	05/2018 fw	
20.07.39 + 40 augšējās vai pamata plātnes iecirtums pievienots	05/2018 fw	7; 12
20.07 41 Metināts galvas rokturis pievienots	05/2018 fw	23

PERI kvalitātes prasības

PEP stutes



PEP ERGO stutes	Nr.	Nosaukums	Artikula Nr.
-----------------	-----	-----------	--------------

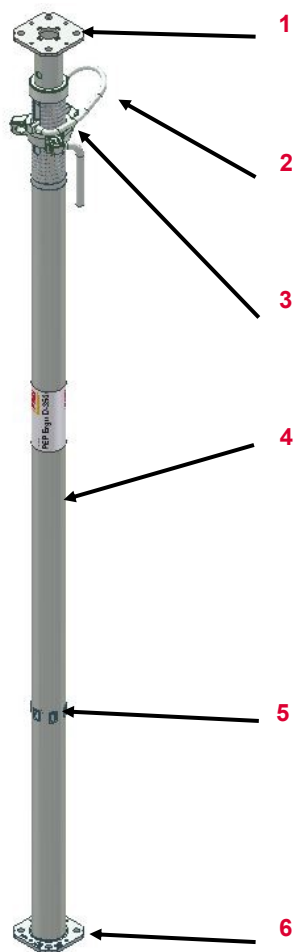











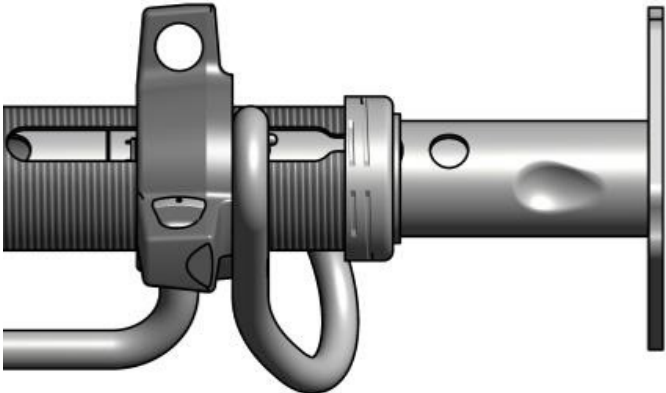

- | | |
|---|------------------------|
| 1 | Augšējā plātne |
| 2 | G- āķis |
| 3 | Regulēšanas uzgrieznis |
| 4 | Ārējā caurule |
| 5 | Marķējums |
| 6 | Pamata platne |

Valid for	Artikula Nr.
Stute PEP ERGO B-300	116780
Stute PEP ERGO B-350	116790
Stute PEP ERGO D-150	117230
Stute PEP ERGO D-250	116770
Stute PEP ERGO D-350	125130
Stute PEP ERGO D-400	125140
Stute PEP ERGO D-500	125150
Stute PEP ERGO E-300	125160
Stute PEP ERGO E-400	125170

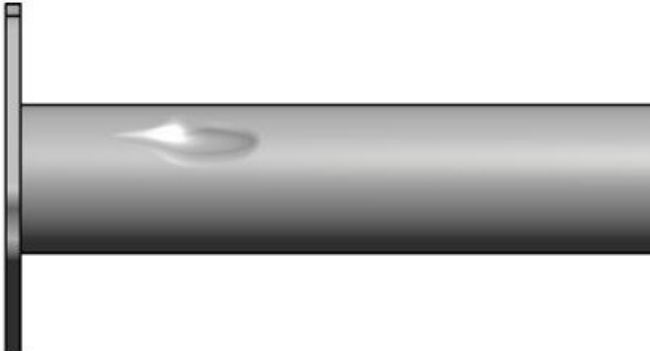
PERI kvalitātes prasības

PEP stutes



Stute	Apraksts	Darbība	Izmaksas	Tips
	20.07.01 Bukte iekšējā caurulē			
	<ul style="list-style-type: none"> ■ Iekšējā caurule iesprūdusi (nav izkustināma) 		 Sk. tab. (lpp. 4)	
	<ul style="list-style-type: none"> ■ Vai buktes dziļums > 7 mm 		 Sk. tab. (lpp. 4)	
	20.07.02 Bukte ārējā caurulē			
	<ul style="list-style-type: none"> ■ Iekšējā caurule iesprūdusi (nav izkustināma) 		 Sk. tab. (lpp. 4)	
	<ul style="list-style-type: none"> ■ Vai buktes dziļums > 7 mm 		 Sk. tab. (lpp. 4)	

PERI kvalitātes prasības

PEP stutes





















Nosaukums	Iekšējās caurules nomaiņa		Ārējās caurules nomaiņa	
	Artikula Nr.	Servisa artikula Nr.	Artikula Nr.	Servisa artikula Nr.
PEP ERGO B-300	116786	088719	116788	088710
PEP ERGO B-350	116794	088720	116769	088711
PEP ERGO D-150	117226	088721	117228	088712
PEP ERGO D-250	116778	088722	116789	088713
PEP ERGO D-350	125543	088723	125546	088714
PEP ERGO D-400	125562	088724	125565	088715
PEP ERGO D-500	125581	088725	125584	088716
PEP ERGO E-300	125588	088726	125591	088717
PEP ERGO E-400	125595	088727	125598	088718

PERI kvalitātes prasības

PEP stutes





















Bojājums Stute	Apraksts	Darbība	Izmaksas	Tips
 <p>Nav pieļaujama plātnes deformācija stutes zonā</p>	20.07.03 Augšējā vai pamata plātne saliekta <ul style="list-style-type: none"> ■ > 10 mm 		 088249	
	20.07.04 Regulēšanas uzgrieznis <ul style="list-style-type: none"> ■ Uzgrieznis izplēsts 		 088235	
	<ul style="list-style-type: none"> ■ Vai plaisa regulēšanas uzgrieznī 		 088235	
	20.07.05 G- āķis <ul style="list-style-type: none"> ■ Iztrūkst 		 088247	
	<ul style="list-style-type: none"> ■ Vai nefunkcionē 		 088247	

PERI kvalitātes prasības

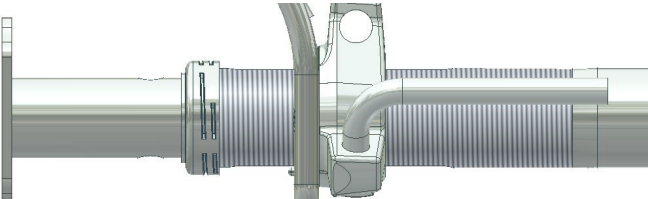
PEP stutes



Stute	Apraksts	Darbība	Izmaksas	Tips
	20.07.06 Plaisa metinājuma šuvē	 		
	20.07.07 Atdures gredzens vaļīgs iztrūkst			
	20.07.08 Karsēta caurule	 		
	20.07.09 Eļļas vai citu smērvielu atliekas uz vītnes			

PERI kvalitātes prasības

PEP stutes



Stute	Apraksts	Darbība	Izmaksas	Tips
	207.07.39 Nogriezums augšējā vai pamata plātnē	 Iekšējā vai ārējā caurule		

PERI kvalitātes prasības

PEP stutes



PEP 20, 30 stutes	Nr.	Nosaukums	Artikula Nr.
-------------------	-----	-----------	--------------

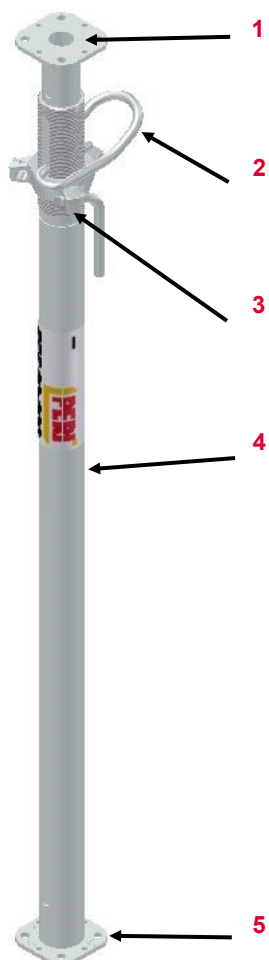











- | | |
|---|------------------------|
| 1 | Augšējā plātne |
| 2 | G - āķis |
| 3 | Regulēšanas uzgrieznis |
| 4 | Ārējā caurule |
| 5 | Pamata plātne |

Valid for	Artikula Nr.
Stute PEP 20-300	103058
Stute PEP 20-350	103059
Stute PEP 20-400	103060
Stute PEP 20-500	103061
Stute PEP 30-150	103066
Stute PEP 30-250	103067
Stute PEP 30-300	103062
Stute PEP 30-350	103063
Stute PEP 30-400	103065

PERI kvalitātes prasības

PEP stutes



Stute	Apraksts	Darbība	Izmaksas	Tips
	<p>20.07.10 Bukte iekšējā caurulē</p> <ul style="list-style-type: none"> ■ Iekšējā caurule iesprūdusi, nav izkustināma 			
	<p>20.07.11 Bukte ārējā caurulē, iekšējā caurule iesprūdusi, nav izkustināma</p> <ul style="list-style-type: none"> ■ Attālums līdz pamata plātnei ≤ 50 cm 		 088249	
	<ul style="list-style-type: none"> ■ Vai attālums līdz pamata plātnei > 50 cm 			

PERI kvalitātes prasības

PEP stutes











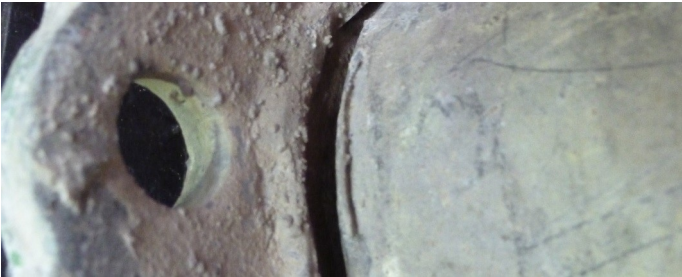





Stute	Apraksts	Darbība	Izmaksas	Tips
	20.07.12 Saliecta augšējā vai pamata plātne <ul style="list-style-type: none"> ■ > 10 mm 		088249	
	20.07.13 Regulēšanas uzgrieznis <ul style="list-style-type: none"> ■ Uzgrieznis izrauts 			
	<ul style="list-style-type: none"> ■ Vai plaisa uzgrieznī 			
	20.07.14 G- āķis <ul style="list-style-type: none"> ■ Iztrūkst 		088247	
	<ul style="list-style-type: none"> ■ Vai nefunkcionē 		088247	

PERI kvalitātes prasības

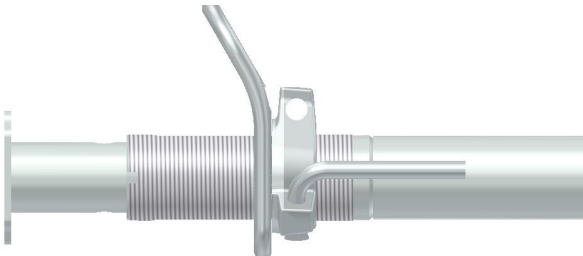
PEP stutes



Prop	Apraksts	Darbība	Izmaksas	Tips
	20.07.15 Plaisa metinājuma šuvē	 		
	20.07.16 Caurule karsēta	 		
	20.07.17 Eļļas vai citu smērvielu atliekas uz vītnes			

PERI kvalitātes prasības

PEP stutes



Stute	Apraksts	Darbība	Izmaksas	Tips
	20.07.40 legriezums augšējā vai pamata plātnē	 		

PERI kvalitātes prasības

PEP stutes



Trijkājis PEP Ergo (107152)	Apraksts	Darbība	Izmaksas	Tips
-----------------------------	----------	---------	----------	------



20.07.18 Deformētas kājas

■ ≤ 10 mm



088244



■ > 10 mm



20.07.19 Deformēts saslēgs

■ ≤ 3 mm



■ > 3 mm



088244



PERI kvalitātes prasības

PEP stutes



Universālais trijkājis (028000)	Nr.	Nosaukums	Artikula Nr.
---------------------------------	-----	-----------	--------------

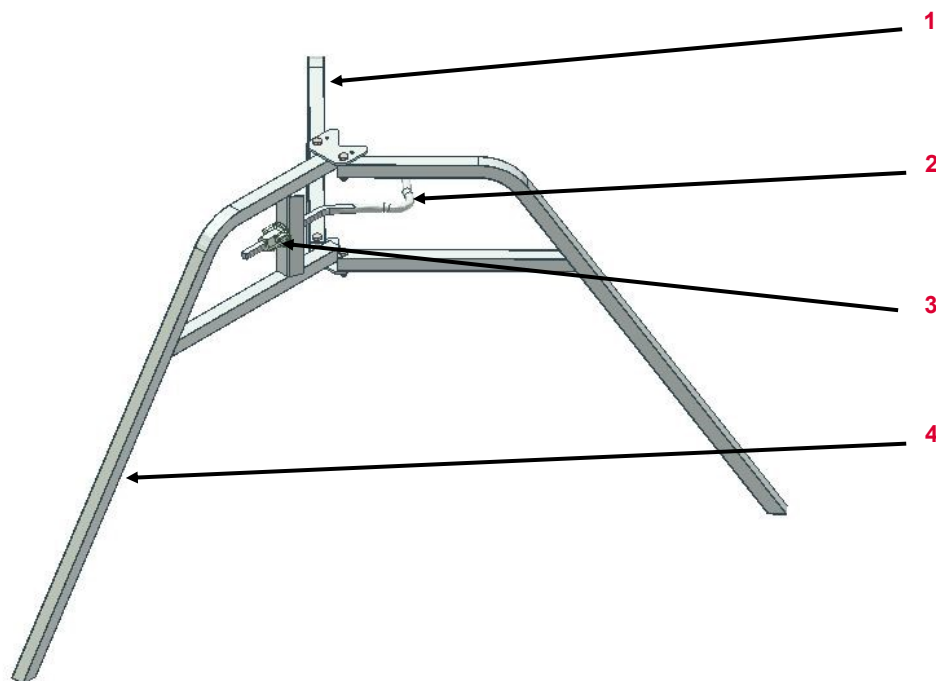















1	Kustīgā svira	715643
2	Spriegošanas cilpa	710161
3	Uzgrieznis	030130
4	Atbalsta kāja	715642

PERI kvalitātes prasības

PEP stutes











Universālais trijkājis	Apraksts	Darbība	Izmaksas	Tips
	<p>20.07.20 Kustīgā svira deformēta</p> <ul style="list-style-type: none"> ■ Ja iespējams ■ Vai ja nav iespējams 	<ul style="list-style-type: none">   	<ul style="list-style-type: none">  088244  715643 (Kustīgā svira) 	<ul style="list-style-type: none">  
	<p>20.07.21 Atbalsta kāja deformēta</p> <ul style="list-style-type: none"> ■ Ja iespējams ■ Vai ja nav iespējams 	<ul style="list-style-type: none">    	<ul style="list-style-type: none">  088244  	<ul style="list-style-type: none">  

PERI kvalitātes prasības

PEP stutes



Universal tripod	Apraksts	Darbība	Izmaksas	Tips
	<p>20.07.22 Spriegošanas cilpa deformēta</p> <ul style="list-style-type: none">■ > 100°			
	<p>20.07.23 Aprauta vīte uzgrieznī</p>	 030130 (uzgrieznis) 767043 (savilce)	 088429	

PERI kvalitātes prasības

PEP stutes



PEP rāmis PRK	Nr.	Nosaukums	Artikula Nr.
---------------	-----	-----------	--------------

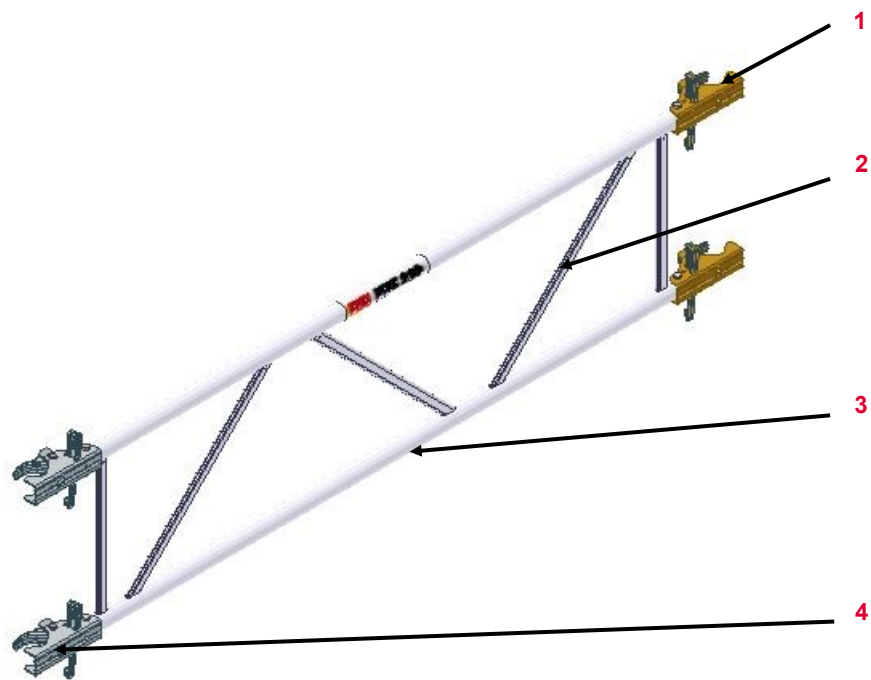

1	Savienojums PRK kr.	112210
2	Statnis	
3	Rāmis	
4	Savienojums PRK lab.	112206

Valid for	Artikula Nr.
Rāmis PRK 62,5	111811
Rāmis PRK 75	111812
Rāmis PRK 100	112813
Rāmis PRK 120	112814
Rāmis PRK 137,5	111815
Rāmis PRK 150	111814
Rāmis PRK 180	115980
Rāmis PRK 200	112718
Rāmis PRK 201,5	111815
Rāmis PRK 210	112788
Rāmis PRK 225	111816
Rāmis PRK 230	111817
Rāmis PRK 266	111818
Rāmis PRK 296	111819

PEP Rāmis PRK	Apraksts	Darbība	Izmaksas	Tips
---------------	----------	---------	----------	------

20.07.24 Izliekums



■ ≤ pieļaujamais izliekums



■ Vai > pieļaujamais izliekums











Artikuls	Pieļ. Izliek.
PRK 62,5	3,0 mm
PRK 75	3,0 mm
PRK 100	3,0 mm
PRK 120	3,0 mm
PRK 137,5	3,0 mm
PRK 150	3,0 mm
PRK 180	3,6 mm
PRK 200	4,0 mm
PRK 201,5	4,0 mm
PRK 210	4,2 mm
PRK 225	4,5 mm
PRK 230	4,7 mm
PRK 266	5,3 mm
PRK 296	5,9 mm

PERI kvalitātes prasības

PEP stutes





PEP Rāmis PRK	Apraksts	Darbība	Izmaksas	Tips
	20.07.25 Savienojums kr. , lab. Deformēts nefunkcionē	 112210 (Savienojums kr.) 112206 (Savienojums lab.)	 088246	
	20.07.26 Plaisa statņa metinājuma šuvē	 		

PERI kvalitātes prasības

PEP stutes

















Pēda MP 50 (027310)	Apraksts	Darbība	Izmaksas	Tips
	20.07.27 Bukte caurulē			
	<ul style="list-style-type: none"> ■ ≤ 6 mm dziļumā un ≤ Ø 60 mm 			
	<ul style="list-style-type: none"> ■ Vai > 6 mm dziļumā 			
	<ul style="list-style-type: none"> ■ Vai > Ø 60 mm 			
 <p>Nav pieļaujama deformācija caurules zonā</p>	20.07.28 Saliekta augšējā vai pamata plātne			
	<ul style="list-style-type: none"> ■ ≤ 15 mm 		088244	
	<ul style="list-style-type: none"> ■ Vai > 15 mm 			

PERI kvalitātes prasības

PEP stutes











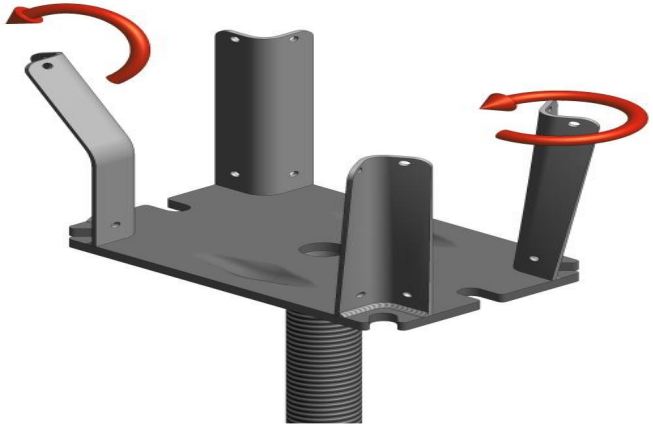





Pēda MP 50 (027310)	Apraksts	Darbība	Izmaksas	Tips
	<p>20.07.29 Atsperes caurule bojāta iztrūkst</p> <ul style="list-style-type: none"> ■ Atsperes caurule 1. versija (melna) ■ Atsperes caurule 2. versija (oranža) 	 	  088367	 
	<p>20.07.30 Spriegotājs bojāts izstrūkst</p>	 <p>780108 (atsperes caurule) 780105 (spriegotājs) 710381 (uzgrieznis) 780702 (paplāksne 2x)</p>		
	<p>20.07.31 Spriegotājs nav pievilkts</p> <ul style="list-style-type: none"> ■ Spriegotājam jābūt pretestībai, kustinot ar roku 			

PERI kvalitātes prasības

PEP stutes



Galva 20/24 (027890)	Apraksts	Darbība	Izmaksas	Tips
	20.07.32 Rags			
	<ul style="list-style-type: none"> ■ Saliects (nav bojāta metinājuma šuve) 		 088395	
	<ul style="list-style-type: none"> ■ Vai saliects (bojāta metinājuma šuve) 		 088394	
	<ul style="list-style-type: none"> ■ Vai iztrūkst 		 088394	
	20.07.33 Izliekta pamata plātne			
<ul style="list-style-type: none"> ■ > 5 mm 	 			

PERI kvalitātes prasības

PEP stutes



Galva 20/24 S (027890 028680)	Apraksts	Darbība	Izmaksas	Tips
-----------------------------------	----------	---------	----------	------













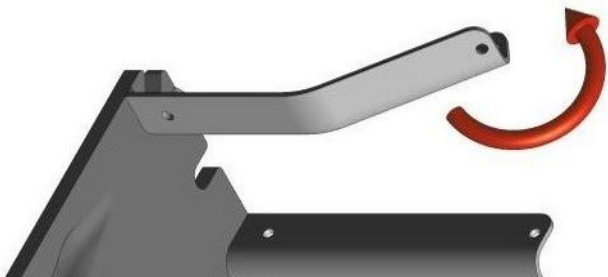







20.07.41 Turētājs piemetināts
(nestandarta metinājums)



PERI kvalitātes prasības

PEP stutes



Galva 20/24S (028680)	Apraksts	Darbība	Izmaksas	Tips
	20.07.34 Rags <ul style="list-style-type: none"> ■ Saliekts (nav bojāta metinājuma šuve) ■ Vai saliekts (bojāta metinājuma šuve) ■ Vai iztrūkst 	  	 088395  088394  088394	  
	20.07.35 Saliekta pamata plātne <ul style="list-style-type: none"> ■ > 5 mm 	 		
	20.07.36 Bojāts fiksators		 088898	

PERI kvalitātes prasības

PEP stutes



Ķīlis (027940; 027790)	Nr.	Nosaukums	Artikula Nr.
------------------------	-----	-----------	--------------

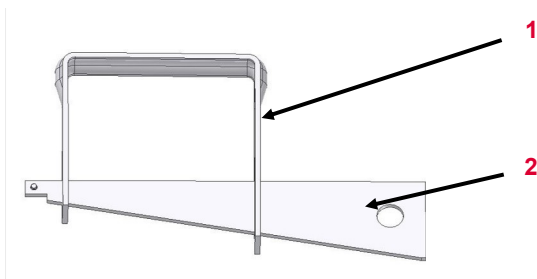

- 1 Skava
- 2 Ķīlis

Bojājums	Apraksts	Darbība	Izmaksas	Tips
----------	----------	---------	----------	------

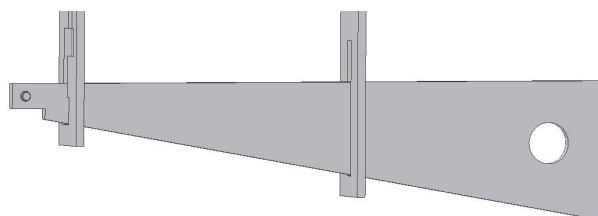

20.07.37 Ķīlis iztrūkst

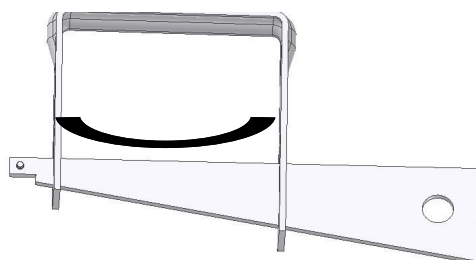

20.07.38 Skava iztrūkst



















088244



PERI kvalitātes prasības

Vārdnīca



Ikona	Nozīme	Ikona	Nozīme	Ikona	Nozīme
	Nav derīgs - materiāls jānoraksta		Jāizraksta rēķins (klientam)		Vizuāls bojājums
	Derīgs - materiāls paliek nomas parkā		Rēķins nav jāizraksta		Funkcionāls bojājums
	Norakstāms materiāls – izdošana nomā nav pieļaujama dēļ neatbilstības drošības prasībām		Saīsināt materiālu		Funkcionāls bojājums - izdošana nomā nav pieļaujama
	Remonts saskaņā ar instrukciju		Marķēt materiālu		Statisks bojājums - izdošana nomā nav pieļaujama
	Aukstā labošana – veicot metinājuma šuvju un blakus detaļu pēcpārbaudi		Nomainīt bojāto materiālu		
	Remonts tikai pēc izmaksu tāmes izvērtēšanas		Atvietot trūkstošo materiālu		
	Materiāla tīrīšana				