

PERI kvalitātes prasības

TRIO

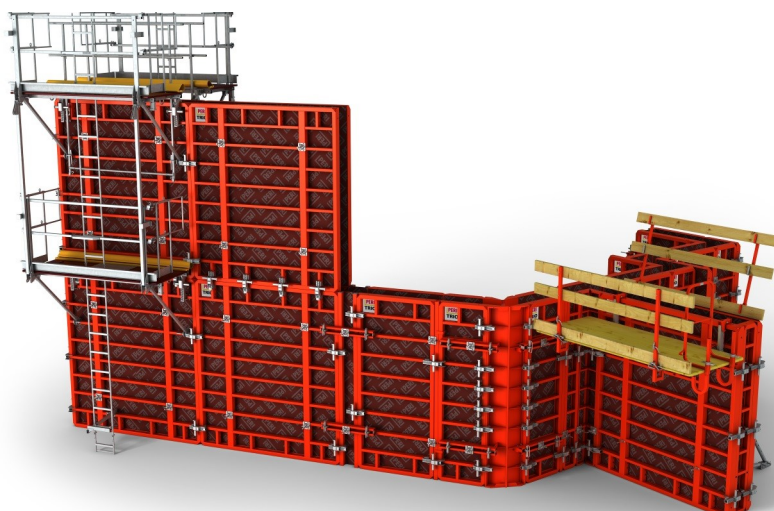

Kontakti

PERI SIA
Betonēšanas veidņi
Tehniskie risinājumi
Sastatnes
Rudeņi 6, Salaspils nov.,
LV-2118, Latvija
info@peri-latvija.lv

Saturs	Lpp.	Izmaiņas	Datums Autors	Lpp.
Rāmja bojājumi, metāls	2	Jaunā versija	09/2015 l fw	
Rāmja bojājumi, alu	13			
TRIO šarnīrveida stūris TGE	20			
TRIO stūra elements TE	23			
Sienas kompensācijas starpliņa	25			
Noslēdzošais panelis	33			
TRIO betonēšanas platforma	41			
TRIO šahtas elements TSE	44			
Piederumi	47			

PERI kvalitātes prasības

TRIO



TRIO Rāmis	Nr.	Nosaukums	Artikula Nr.
------------	-----	-----------	--------------

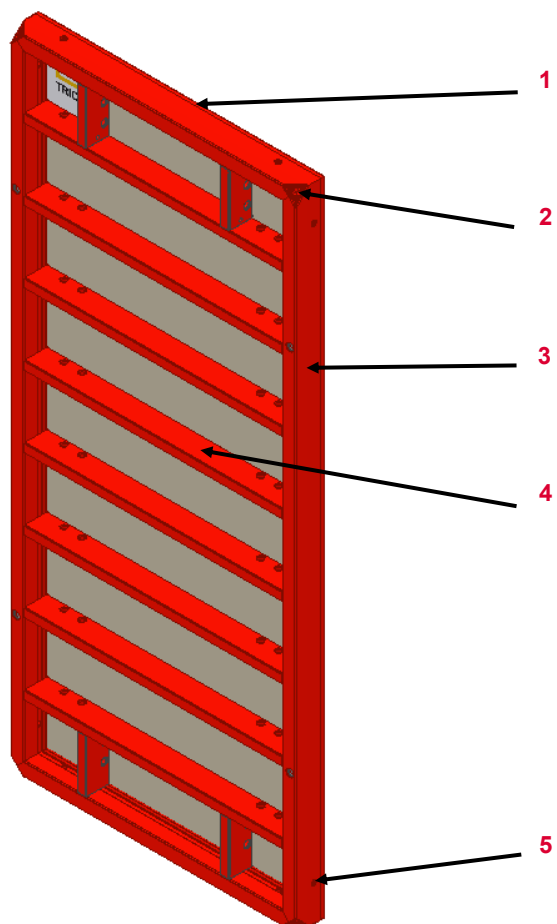

1	Gala profils	
2	Sviras stūris	750580
3	Sāna profils	
4	Statnis	
5	Stiprinājuma čaula (uzmava)	750127













PERI kvalitātes prasības

















TRIO

















Artikuls	Artikula Nr.
Panelis TR/4 330x240	054304
Panelis TR/4 330x120	054314
Panelis TR/4 330x90	054324
Panelis TR/4 330x72	054334
Panelis TR/4 330x60	054354
Panelis TR/4 330x30	054364
Panelis TRM/4 330x72	054344
Noslēdzošais panelis TR/4 330x24	023050
Panelis TR 270x240	022570
Panelis TR 270x120	022510
Panelis TR 270x90	022520
Panelis TR 270x72	022530
Panelis TR 270x60	022550
Panelis TR 270x30	022560
Panelis TRM 270x 72	022540
Noslēdzošais panelis TR 270x24	023040

Artikuls	Artikula Nr.
Panelis TR 120x240	022514
Panelis TR 120x120	022600
Panelis TR 120x90	022610
Panelis TR 120x72	022620
Panelis TR 120x60	022640
Panelis TR 120x30	022650
Panelis TRM 120x72	022630
Noslēdzošais panelis TR 120x24	023030
Panelis TR60x90	022790
Panelis TR60x72	022800
Panelis TR60x60	022810
Panelis TR60x30	022820

Rāmja bojājumi, metāls	Apraksts	Darbība	Izmaksas	Tips
	27.01 Rāmja vai statņa daļas atrautas, trūkst	 		
	27.02 Deformēts gala profils <ul style="list-style-type: none"> ■ Celtna āķa radīts iespiebums bukte ■ Vai mehāniskas iedarbības rezultātā radīts bojājums 	 	 	Sk. tab. 11. lpp.  Sk. tab. 11. lpp. 

Rāmja bojājumi, metāls	Apraksts	Darbība	Izmaksas	Tips
	27.03 Deformēts sāna profils <ul style="list-style-type: none"> ■ Celtna āķa radīts bojājums ■ ■ Vai mehāniskas iedarbības rezultātā radīts bojājums 	 	 	 
	27.04 Caurums rāmja profilā <ul style="list-style-type: none"> ■ ≤ Ø 3 cm ■ Vai > Ø 3 cm sāna profilā ■ Vai > Ø 3 cm gala profilā vai statnī 	  	 088028   Sk. tab. (lpp. 11+12)	  

Rāmja bojājumi, metāls	Apraksts	Darbība	Izmaksas	Tips
	27.05 Statnis bukta deformēts		 Sk. tab. (lpp. 12)	
	27.06 Statņa siptinājuma čaulas bojājums deformācija			
	<ul style="list-style-type: none"> ■ Ja ir iespējama taisnošana 		 088244	
	<ul style="list-style-type: none"> ■ Ja taisnošana nav iespējama 		 Sk. tab. (lpp. 12)	
	<ul style="list-style-type: none"> ■ Vai ja čaula atrauta, vai izplēsts caurums 		 Sk. tab. (lpp. 12)	

Rāmja bojājumi, metāls	Apraksts	Darbība	Izmaksas	Tips
------------------------	----------	---------	----------	------

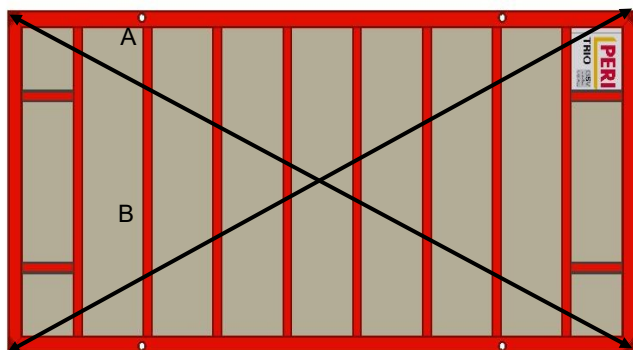

27.07 Rāmja profils saliekts pa diagonāli















- Starpība starp A un B > 6 mm























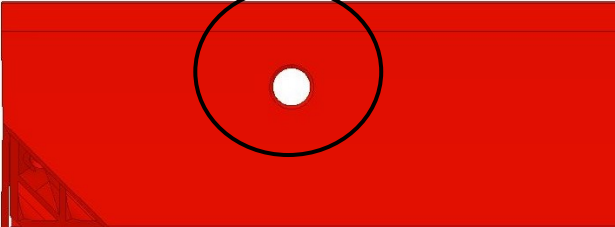

27.08 Panelis saliekts

- > 8 mm



Rāmja bojājumi, metāls	Apraksts	Darbība	Izmaksas	Tips
	27.09 Bukte profilā <ul style="list-style-type: none"> ■ ≤ 5 mm dziļumā 	 		
	<ul style="list-style-type: none"> ■ Vai > 5 mm dziļumā 		 088027	
	27.10 Bukte profila kantī <ul style="list-style-type: none"> ■ > 3 mm līdz ≤ 10 mm 		 088236	
	<ul style="list-style-type: none"> ■ Vai > 10 mm 	 Noņemt saplākšņa virsmu	 088236	

Rāmja bojājumi, metāls	Apraksts	Darbība	Izmaksas	Tips
	27.11 Metinājuma šuves plaisa plīsums		 088028	
	27.12 Plaisa profila kantī			
	<ul style="list-style-type: none"> ■ Profila kants salocīca 		 088028	
	<ul style="list-style-type: none"> ■ Profila kants nav deformēta 		 088028	

Rāmja bojājumi, metāls	Apraksts	Darbība	Izmaksas	Tips
	27.13 Deformēts sviras stūris		 088176	
	27.14 Caula bojāta iztrūkst		 088002	
	27.15 Caurrūsējis rāmja profils	<ul style="list-style-type: none">   		

PERI kvalitātes prasības

TRIO



Artikuls	Gala profils	
	Rezerves daļa	Servisa artikula Nr.
Gala profils 30	109106	088049
Gala profils 60	109031	088051
Gala profils 90	109023	088052
Gala profils 120	109021	088053
Gala profils 240	745051	088054
Gala profils 270	745050	088055

PERI kvalitātes prasības

TRIO



Artikuls	Statnis	
	Rezerves daļa	Servisa artikula Nr.
Savienojums 18	745357	088038
Savienojums 19	112479	088039
Savienojums 22	745356	088040
Savienojums 43	745355	088043
Savienojums 48	745354	088044
Savienojums 78	745352	088046
Savienojums 122	745350	088047
Savienojums 60	745353	088232
Savienojums 23	745358	

Rāmja bojājumi, alu

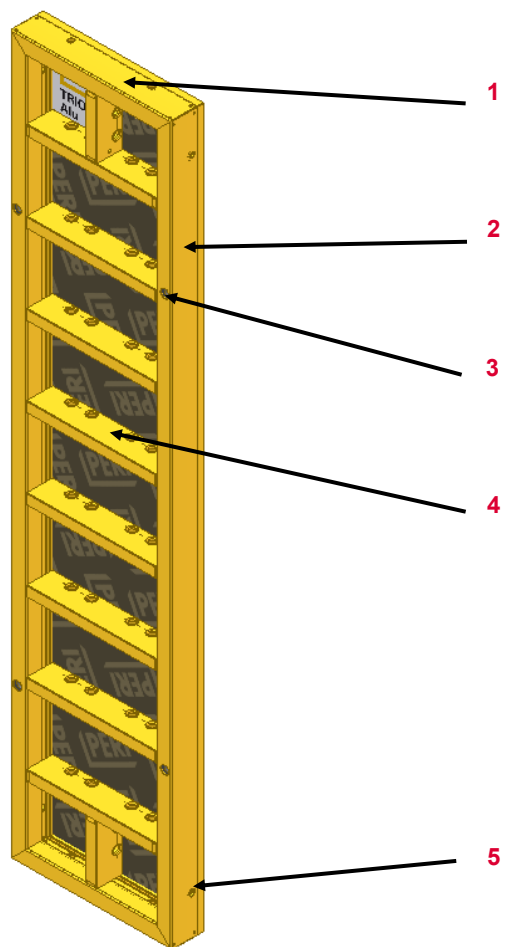









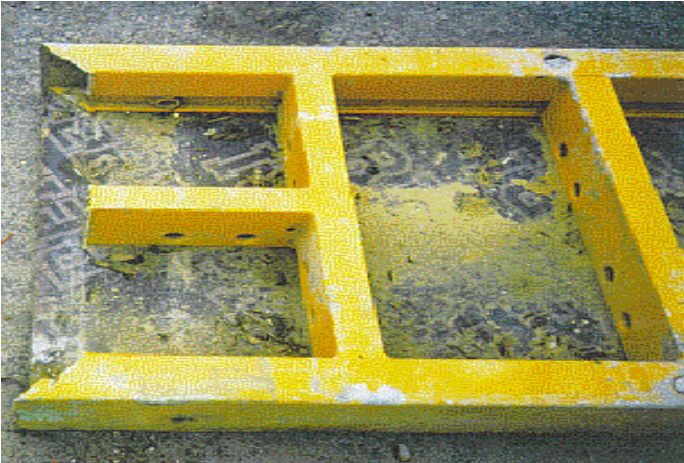

Nr.	Nosaukums	Artikula Nr.
1	Gala profils	
2	Sānu profils	
3	Stiprinājuma čaula 18	710160
4	Statnis	
5	Stiprinājuma čaula 8	750120













Valid for	Artikula Nr.
Panelis TRA 270x90	023850
Panelis TRA 270x60	023870
Panelis TRA 270x30	023880
Panelis TRA 90x120	023900
Panelis TRA 90x60	023950
Panelis TRA 90x30	023960
Multipanelis TAM 270x72	023860
Multipanelis TAM 90x72	023980











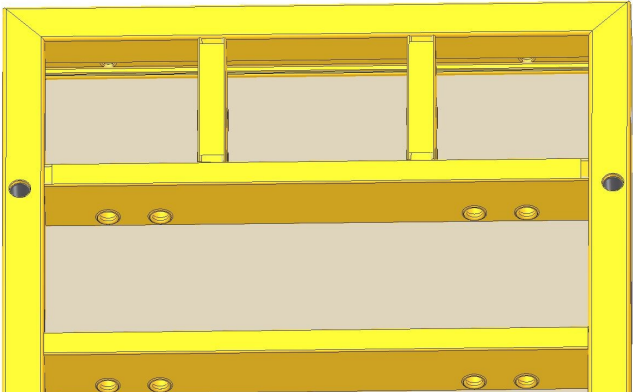

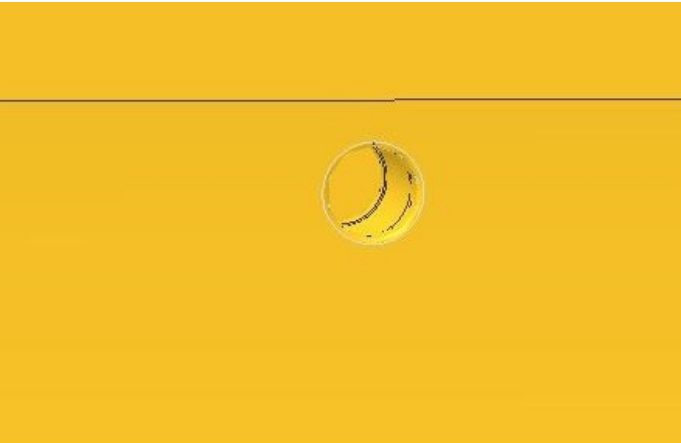

PERI kvalitātes prasības

TRIO



Rāmja bojājumi, alu	Apraksts	Darbība	Izmaksas	Tips
	27.16 Profilu daļas, statņi atrauti			
	27.17 Bojāts gala profils			
	<ul style="list-style-type: none"> ■ Celtņa āķa radīta deformācija buk- te  ■ Vai mehāniskas iedarbības rezultātā radīts bojājums  	 	 	

Rāmja bojājumi, alu	Apraksts	Darbība	Izmaksas	Tips
	27.18 Bojāts sāna profils			
	<ul style="list-style-type: none"> ■ Celtna āķa radīta deformācija buk- te 	 		
	<ul style="list-style-type: none"> ■ Vai mehāniskas iedarbības rezultātā radīts bojājums 	 		
	27.19 Caurumi profilā			

Rāmja bojājumi, alu	Apraksts	Darbība	Izmaksas	Tips
	27.20 Bukte statnī			
	27.21 Statņa stiprinājuma čaula deformēta izrauta			
	<ul style="list-style-type: none"> ■ Ja taisnošana ir iespējama 		 088244	
	<ul style="list-style-type: none"> ■ Ja taisnošana nav iespējama 		 088002	
	<ul style="list-style-type: none"> ■ Vai stiprinājuma čaula izrauta 		 088002	

Rāmja bojājumi, alu	Apraksts	Darbība	Izmaksas	Tips
---------------------	----------	---------	----------	------

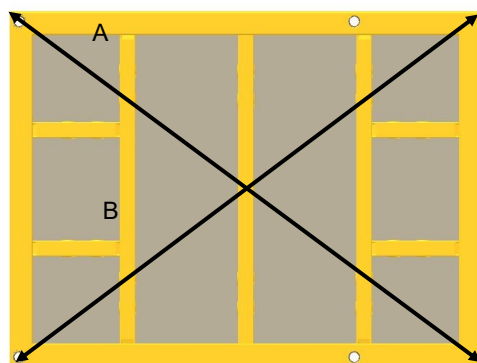

27.22 Rāmja profils saliekts pa diagonāli



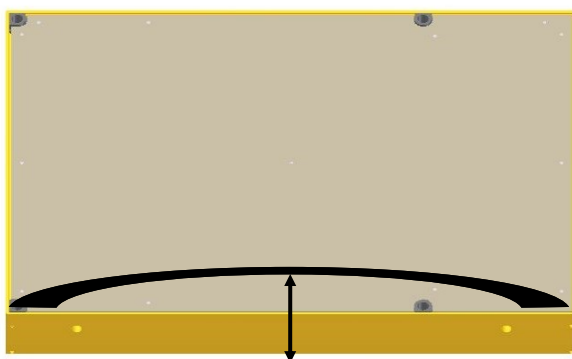

- Starpība starp A un B > 6 mm



27.23 Panelis izliekts

- > 8 mm











Rāmja bojājumi, alu	Apraksts	Darbība	Izmaksas	Tips	
	27.24 Bukte profilā <ul style="list-style-type: none"> ■ ≤ 5 mm dziļumā 	 			
	<ul style="list-style-type: none"> ■ Vai > 5 mm dziļumā 			088027	
	27.25 Iebuktēta profila kants <ul style="list-style-type: none"> ■ ≤ 3 mm 	 			
	<ul style="list-style-type: none"> ■ Vai > 3 mm līdz ≤ 10 mm 			0882636	
	<ul style="list-style-type: none"> ■ Vai > 10 mm 		Noņemt saplākšņa virsmu		088236 

PERI kvalitātes prasības

TRIO



Rāmja bojājumi, alu	Apraksts	Darbība	Izmaksas	Tips
	27.26 Metinājuma šuves plaisa plīsums		 088243	
	27.27 Iekšējās metinājuma šuves plaisa plīsums		 088243	

PERI kvalitātes prasības

TRIO



TRIO šarnīrveida stūris TGE

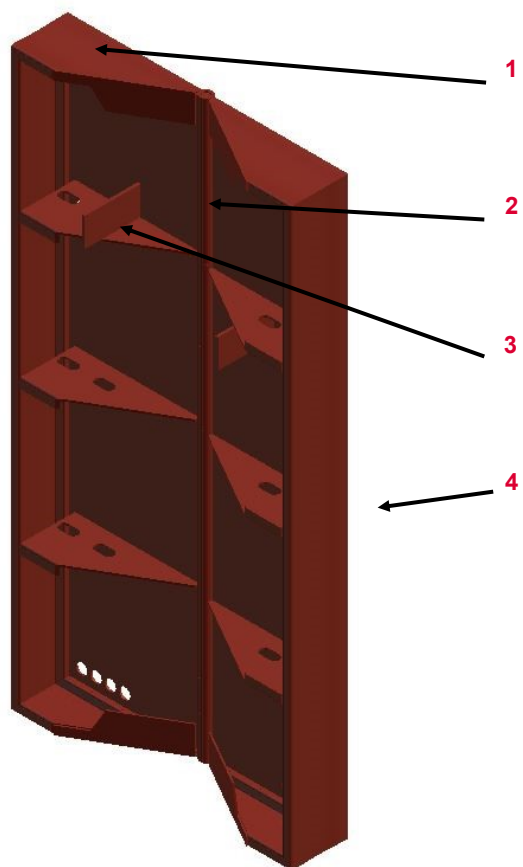

Nr.	Nosaukums	Artikula Nr.
1	Nosegplāksne	722066
2	Vira	
3	Metāla sieniņa	740211
4	Darba virsma	

Valid for	Artikula Nr.
TRIO šarnīrveida stūris TGE/4 330	054414
TRIO šarnīrveida stūris TGE 270	023200
TRIO šarnīrveida stūris TGE 120	023300

TRIO šarnīrveida stūris TGE	Apraksts	Darbība	Izmaksas	Tips
	27.28 Iespiedums vai bukte profilā vai uz darba virsmas			
	<ul style="list-style-type: none"> ■ ≤ 3 mm 			
	<ul style="list-style-type: none"> ■ Vai > 3 mm līdz ≤ 10 mm 			
	<ul style="list-style-type: none"> ■ Vai > 10 mm 			
	27.29 Rāmja profils saliekts pa diagonāli			
	<ul style="list-style-type: none"> ■ Starpība starp A un B > 5 mm 			

TRIO šarnīrveida stūris TGE	Apraksts	Darbība	Izmaksas	Tips
-----------------------------	----------	---------	----------	------

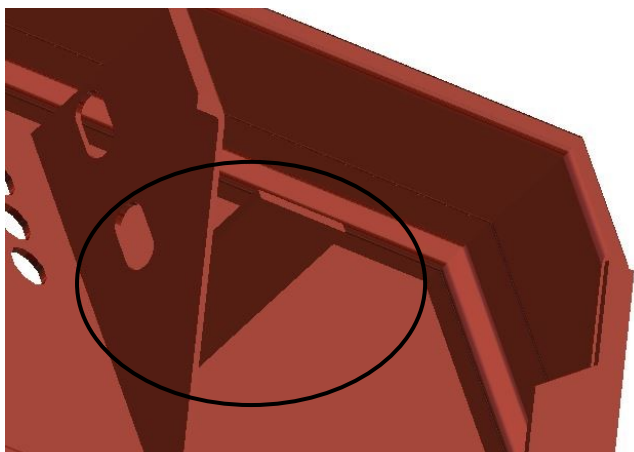

27.30 Saliakta metāla sienīņa



088244

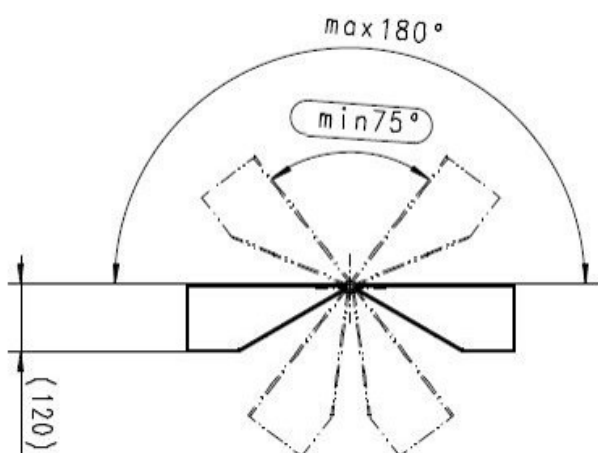

27.31 Function

■ Nekustas brīvi



Saeļlot viru



■ Nefunkcionē



■ Pēc tīrīšanas un remonta tik un tā nefunkcionē



PERI kvalitātes prasības

TRIO



TRIO stūra elements TE	Nr.	Nosaukums	Artikula Nr.
------------------------	-----	-----------	--------------

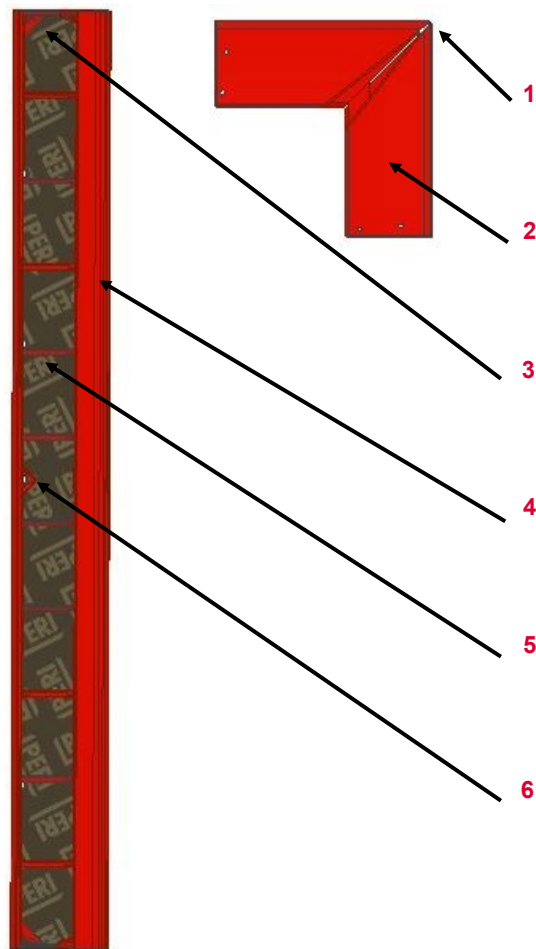

1	Stūra loksne	
2	Gala profils	
3	Kronšteins	740205
4	Sāna profils	
5	Statnis	
6	Pārklājuma atbalsts	721794

Valid for	Artikelnummer
Stūra elements TAE 270-2	023891
Stūra elements TAE 90-2	023971
Stūra elements 270-2	022580
Stūra elements 120-2	022660
Stūra elements 60-2	022840

PERI kvalitātes prasības

TRIO



TRIO stūra elements TE	Apraksts	Darbība	Izmaksas	Tips
------------------------	----------	---------	----------	------

27.32 Izliekums

- > 8 mm

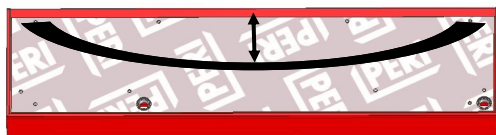

27.33 Deformēts leņķis

- > 10 mm

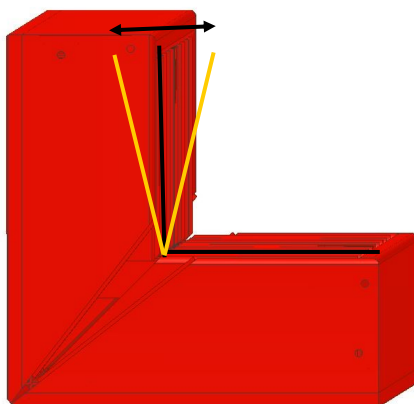

PERI kvalitātes prasības

TRIO





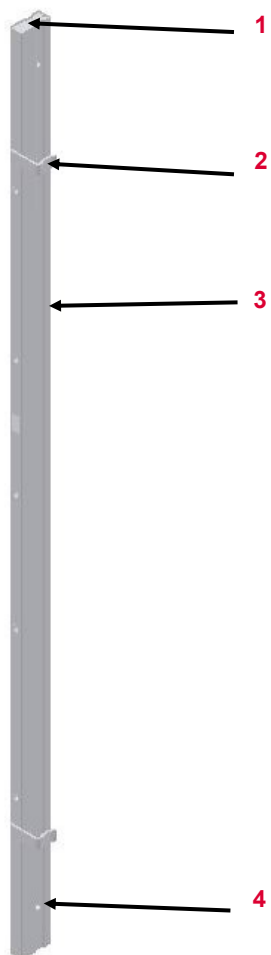





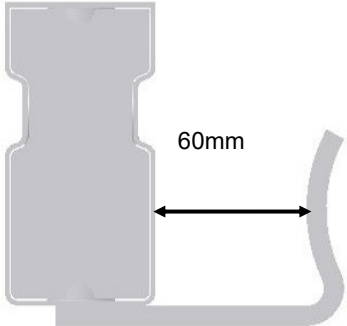

TRIO starplika ,tērauda





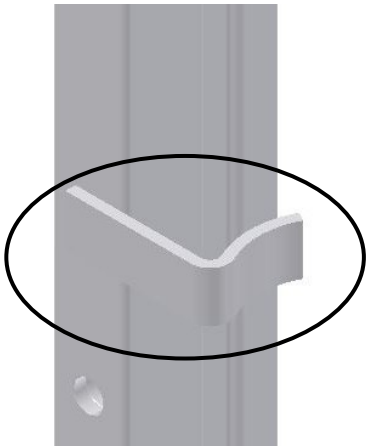



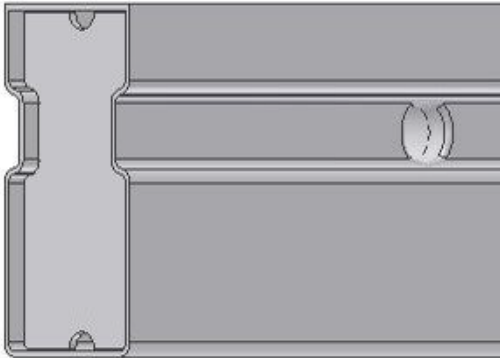

Nr.	Nosaukums	Artikula Nr.
1	Noseglātne	
2	Profils	
3	Betonēšanas virsma	
4	Stiprinājuma čaula	

Valid for	Artikula Nr.
TRIO starplika, tērauda WDA/4 330x6	054401
TRIO starplika, tērauda WDA/4 330x5	054391
TRIO starplika, tērauda WDA-2 270x6	023192
TRIO starplika, tērauda WDA-2 270x5	023182
TRIO starplika, tērauda WDA-2 120x6	023292
TRIO starplika, tērauda WDA-2 120x5	023282

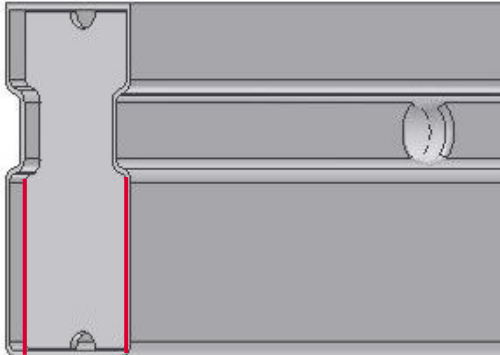
Starplika	Apraksts	Darbība	Izmaksas	Tips
	27.34 Izliekums <ul style="list-style-type: none"> ■ > 8 mm 			
	27.35 Bukte betonēšanas virsmā <ul style="list-style-type: none"> ■ ≤ 3 mm ■ Vai > 3 mm līdz ≤ 10 mm ■ Vai > 10 mm 	<ul style="list-style-type: none">     	<ul style="list-style-type: none">    	<ul style="list-style-type: none">   

Profils	Apraksts	Darbība	Izmaksas	Tips
	27.36 Deformēts profils			
	<ul style="list-style-type: none"> ■ ≤ 10 mm ■ Vai > 10 mm 	 	 088244  088164	 
	27.37 Profils iztrūkst		 088164	

Noseglātne	Apraksts	Darbība	Izmaksas	Tips
	<p>27.38 Deformēta noseglātne (bez metinājuma šuves bojājumiem)</p>			
	<p>27.39 Deformēta noseglātne (bojāta metinājuma šuve)</p>			

PERI kvalitātes prasības

TRIO





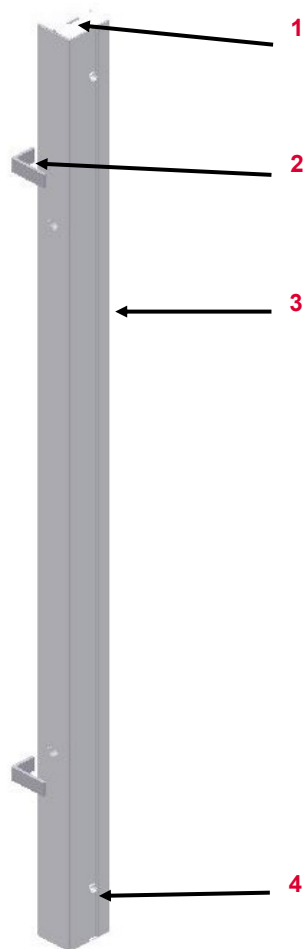





TRIO starplika alu

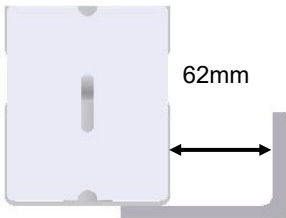









Nr.	Nosaukums	Artikula Nr.
1	Nosegplātne	101959
2	Profils	
3	Betonēšanas virsma	
4	Čaula	

Valid for	Artikula Nr.
TRIO starplika, tērauda WDA/4 330x10 Alu	054435
TRIO starplika, tērauda WDA 270x10 Alu	023995
TRIO starplika, tērauda WDA 120x10 Alu	023990

Starplika	Apraksts	Darbība	Izmaksas	Tips
	<p>27.40 Izliekums</p> <ul style="list-style-type: none"> ■ > 8 mm 			
	<p>27.41 Bukte betonēšanas virsmā</p> <ul style="list-style-type: none"> ■ ≤ 3 mm 			
	<ul style="list-style-type: none"> ■ Vai > 3 mm līdz ≤ 10 mm 			
	<ul style="list-style-type: none"> ■ Vai > 10 mm 			

Profils	Apraksts	Darbība	Izmaksas	Tips
	27.42 Deformēts profils <ul style="list-style-type: none"> ■ ≤ 10 mm ■ Vai > 10 mm 	 	 088244  088000	 
	27.43 Profils iztrūkst		740781 (WDA 120) 740776 (WDA 270 + 330)	 088000

Noseglātne	Apraksts	Darbība	Izmaksas	Tips	
	<p>27.44 Deformēta noseglātne (metināšanas šuve bez bojājumiem)</p>				
	<p>27.45 Deformēta noseglātne (bojāta metināšanas šuve)</p>			<p>088001</p>	

PERI kvalitātes prasības

TRIO



Noslēdzošais panelis AT

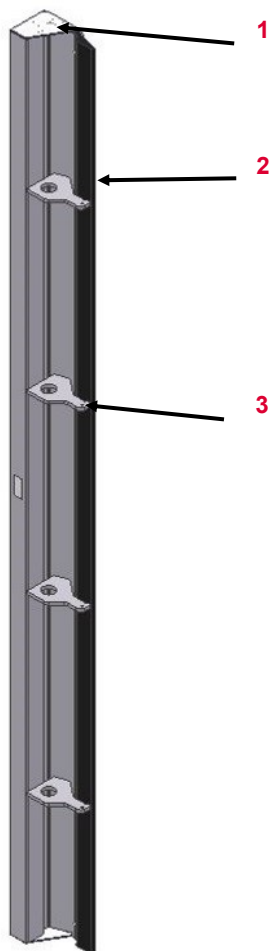









Nr.	Nosaukums	Artikula Nr.
1	Nosegplātne	100782
2	Blīvējošais profils	
3	Āķis	100781

Valid for	Artikula Nr.
Noslēdzošais panelis TRIO AT 270x5	105953
Noslēdzošais panelis TRIO AT 270x3	023060
Noslēdzošais panelis TRIO AT 120x5	105978
Noslēdzošais panelis TRIO AT 120x3	023067

PERI kvalitātes prasības

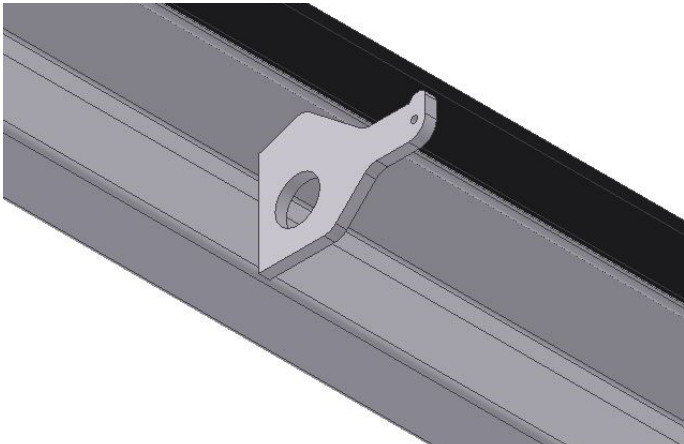
TRIO



Profils	Apraksts	Darbība	Izmaksas	Tips
	<p>27.46 Bīvējošais profils iegriezts saplēsts</p> <ul style="list-style-type: none">■ > 3 mm dziļumā			
	<p>27.47 Āķis nolauzts vai iztrūkst</p>		 088154	





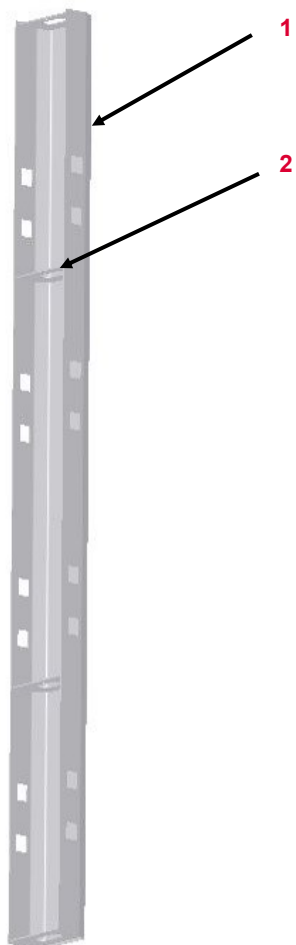



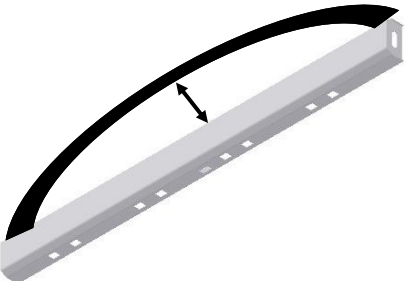

Profils	Apraksts	Darbība	Izmaksas	Tips
	<p>27.48 Izliekums</p> <ul style="list-style-type: none"> ■ > 8 mm 			
	<p>27.49 Bojāta noseglātne</p> <ul style="list-style-type: none"> ■ > 3 mm līdz ≤10 mm 		 088244	
	<ul style="list-style-type: none"> ■ Vai > 10 mm 		 088151	

Noslēdzošais panelis MT	Nr.	Nosaukums	Artikula Nr.
-------------------------	-----	-----------	--------------

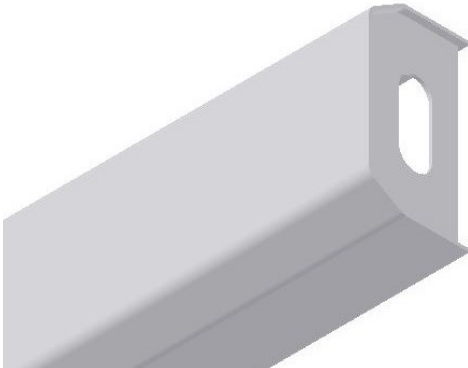

1	Profils	
2	Nosegplātne	

Valid for	Artikula Nr.
Noslēdzošais panelis TRIO MT 270x35/36	023065
Noslēdzošais panelis TRIO MT 270x30	023064
Noslēdzošais panelis TRIO MT 270x24/25	023062
Noslēdzošais panelis TRIO MT 270x20	023061
Noslēdzošais panelis TRIO MT 120x35/36	023072
Noslēdzošais panelis TRIO MT 120x30	023071
Noslēdzošais panelis TRIO MT 120x24/25	023069
Noslēdzošais panelis TRIO MT 120x20	023068



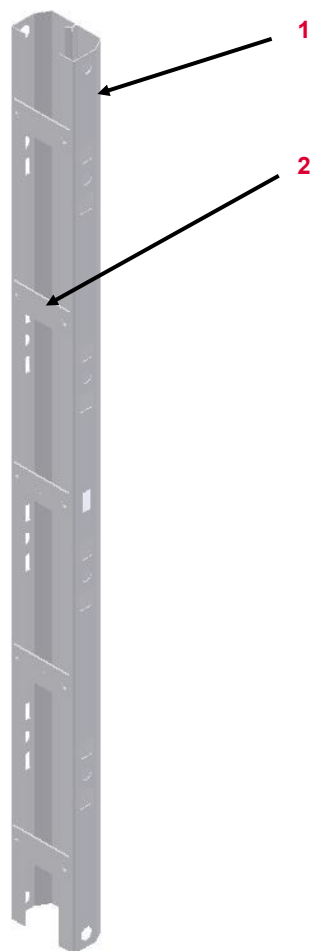

Noslēdzošais panelis MT	Apraksts	Darbība	Izmaksas	Tips	
	<p>27.50 Izliekums</p> <ul style="list-style-type: none"> ■ > 8 mm 				
	<p>27.51 Deformēta noseplatne</p> <ul style="list-style-type: none"> ■ Metinājuma šuve nav bojāta ■ Vai metinājuma šuve ir bojāta 			<p>088244</p>	
					

Noslēdzošais panelis MTF

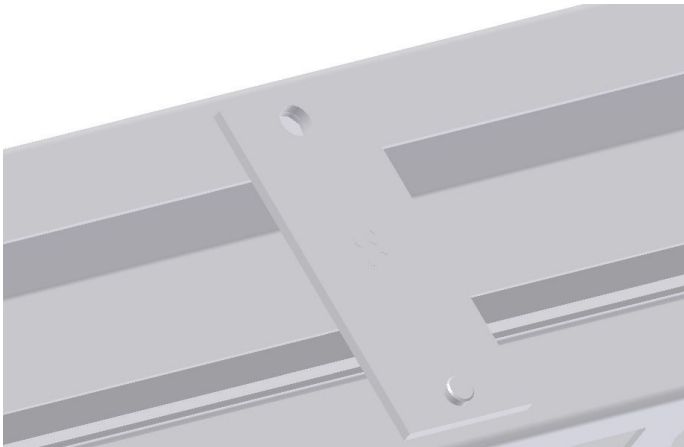

Nr.	Nosaukums	Artikula Nr.
1	Profils	
2	Plāksne	

Valid for	Artikula Nr.
Noslēdzošais panelis TRIO MTF 270x35/36	023076
Noslēdzošais panelis TRIO MTF 270x30	023077
Noslēdzošais panelis TRIO MTF 270x24/25	023075
Noslēdzošais panelis TRIO MTF 270x20	023074
Noslēdzošais panelis TRIO MTF 120x35/36	023079
Noslēdzošais panelis TRIO MTF 120x30	023078
Noslēdzošais panelis TRIO MTF 120x24/25	023080
Noslēdzošais panelis TRIO MTF 120x20	023081

Noslēdzošais panelis MTF	Apraksts	Darbība	Izmaksas	Tips
	<p>27.52 Izliekums</p> <ul style="list-style-type: none"> ■ > 8 mm 			
	<p>27.53 Plāksne deformēta Iztrūkst</p>			

PERI kvalitātes prasības

TRIO



Betonēšanas platforma TRIO 120x270 (022950)			
Nr.	Nosaukums	Artikula Nr.	

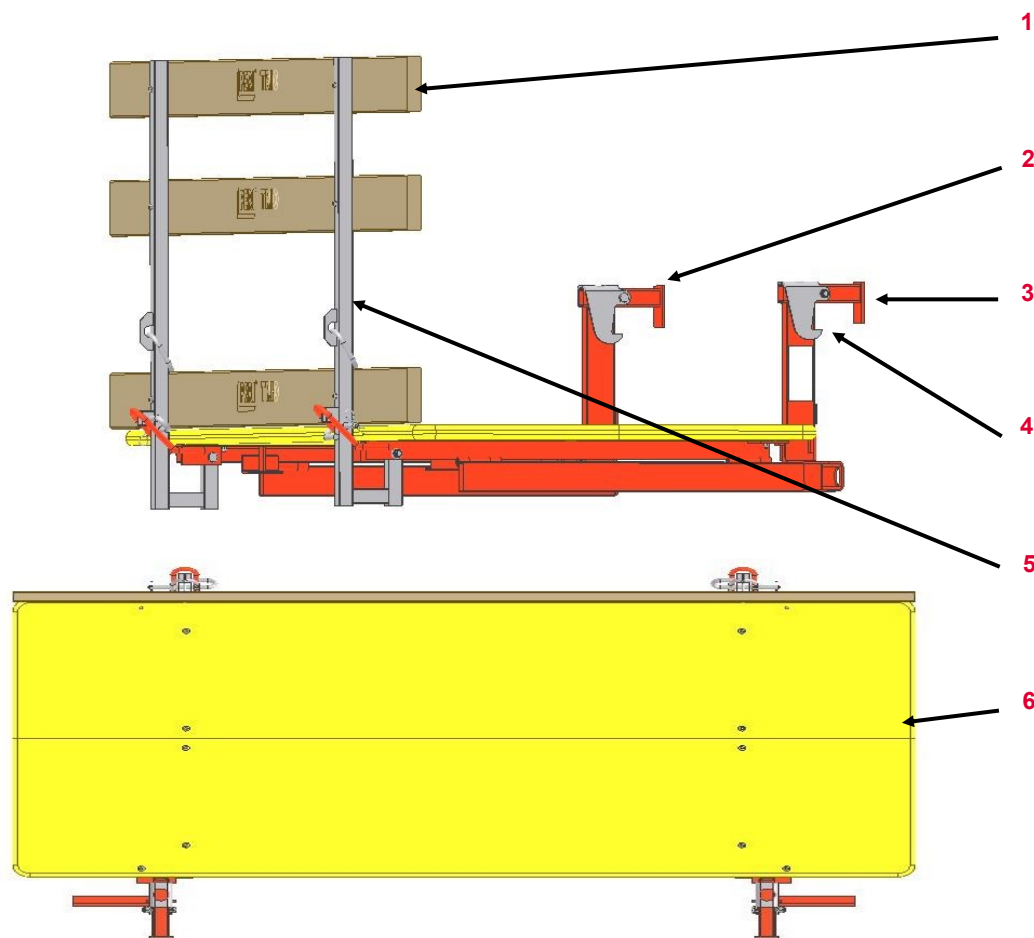

1	TRIO margā	022980
2	Platformas kronšteins, kr.	022970
3	Platformas kronšteins, lab.	022960
4	Pacelšanas acs	721726
5	Margu stabs	102623
6	Saplākšņa plāksne	022995

PERI kvalitātes prasības

TRIO



Betonēšanas platforma TRIO	Apraksts	Darbība	Izmaksas	Tips
----------------------------	----------	---------	----------	------



27.54 Marga bojāta | iztrūkst



022980



088215

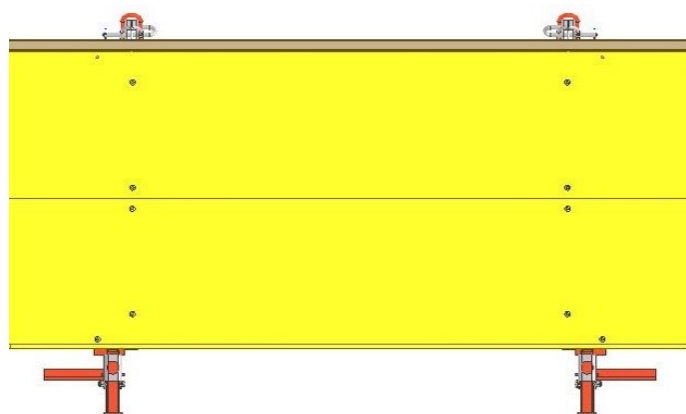

27.55 Nolietojusies saplākšņa plāksne















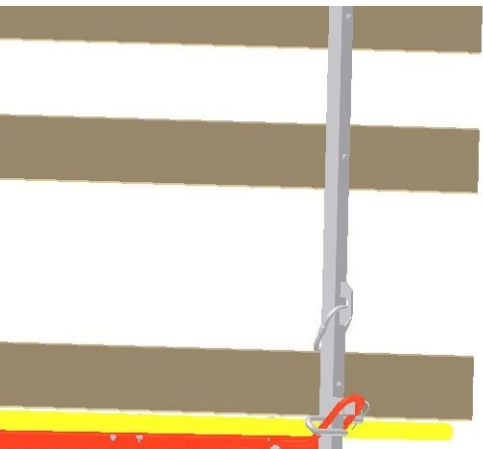





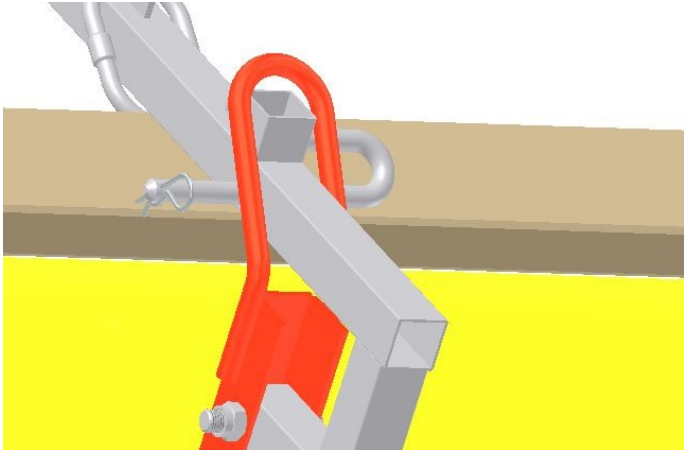





022995

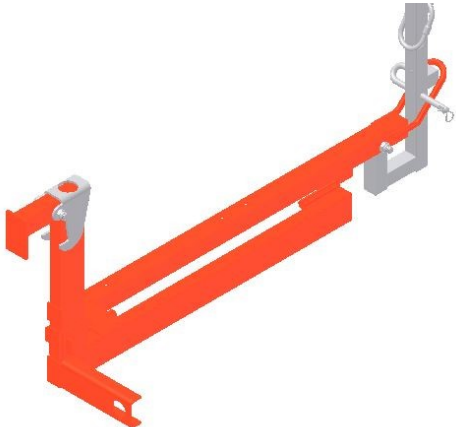

088214



Betonēšanas platforma TRIO	Apraksts	Darbība	Izmaksas	Tips
	27.56 Bojāta pacelšanas acs	 721726	 088219	
	27.57 Margas stabs bojāts deformēts	 102623		

Betonēšanas platforma TRIO	Apraksts	Darbība	Izmaksas	Tips
	27.58 Deformēts kronšteins			
	<ul style="list-style-type: none"> ■ Plaisa metinājuma šuvē 	 102621 (betonēšanas platforma lab.)  102622 (betonēšanas platforma kr.)	 088216  088217	
	<ul style="list-style-type: none"> ■ Vai deformēta 	 102621 (betonēšanas platforma lab.)  102622 (betonēšanas platforma kr.)	 088216  088217	
	27.59 Deformēts platformas kronšteins			
		 102621 (betonēšanas platforma lab.)  102622 (betonēšanas platforma kr.)	 088216  088217	

PERI kvalitātes prasības

TRIO





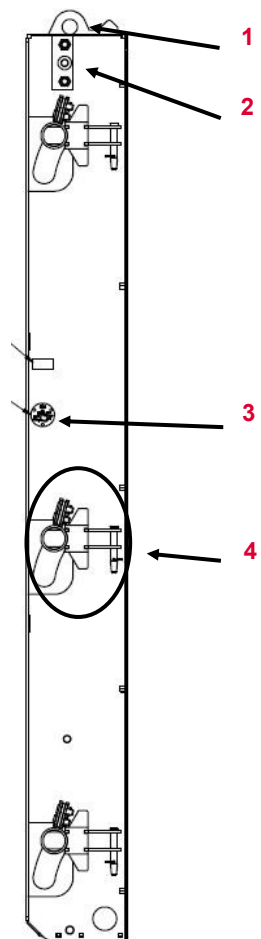





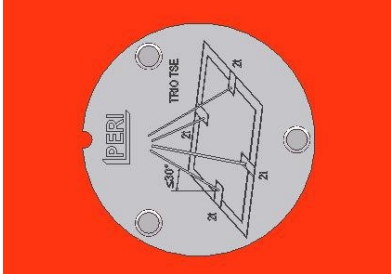







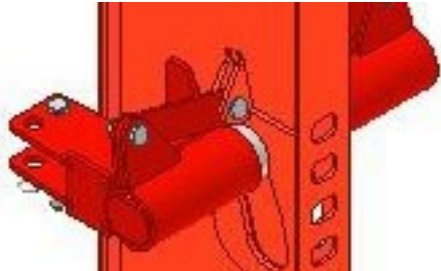







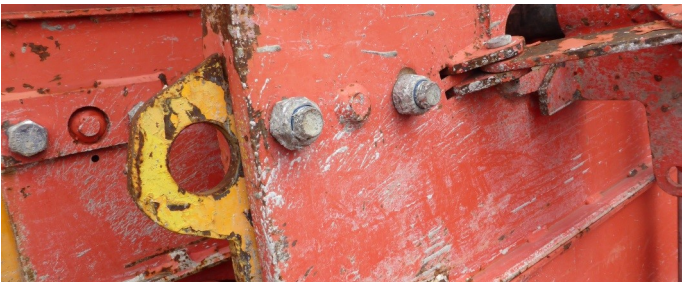

TRIO šaftas elements TSE



Nr.	Nosaukums	Artikula Nr.
1	Pacelšanas acs	108336
2	Stiprinājums TSE	113214
3	Informācijas plāksne	105599
4	Mehānisms	

Valid for	Artikula Nr.
Šaftas elements TSE 330	105525
Šaftas elements TSE 270	105523
Šaftas elements TSE 120	105524

Šahtas elements TSE	Apraksts	Darbība	Izmaksas	Tips
	27.60 Informācijas plāksne iztrūkst	 105599 (Informācijas plāksne)		
	27.61 Stūris mehāniski deformēts			
	27.62 Mehānisms iesprūdis, nav izkustināms			

Šahtas elements TSE	Apraksts	Darbība	Izmaksas	Tips
	27.63 Salocīta vai izstrūkst paceļšanas acs	 108336	 088208	
	27.64 Iztrūks stiprinājums TSE			
	27.65 Deformētas mehānisma plāksnes		 088244	
	<ul style="list-style-type: none"> ■ Ja iespējams ■ Vai ja nav iespējams 		 088197	

PERI kvalitātes prasības

TRIO



Profils TPP	Nr.	Nosaukums	Artikula Nr.
-------------	-----	-----------	--------------

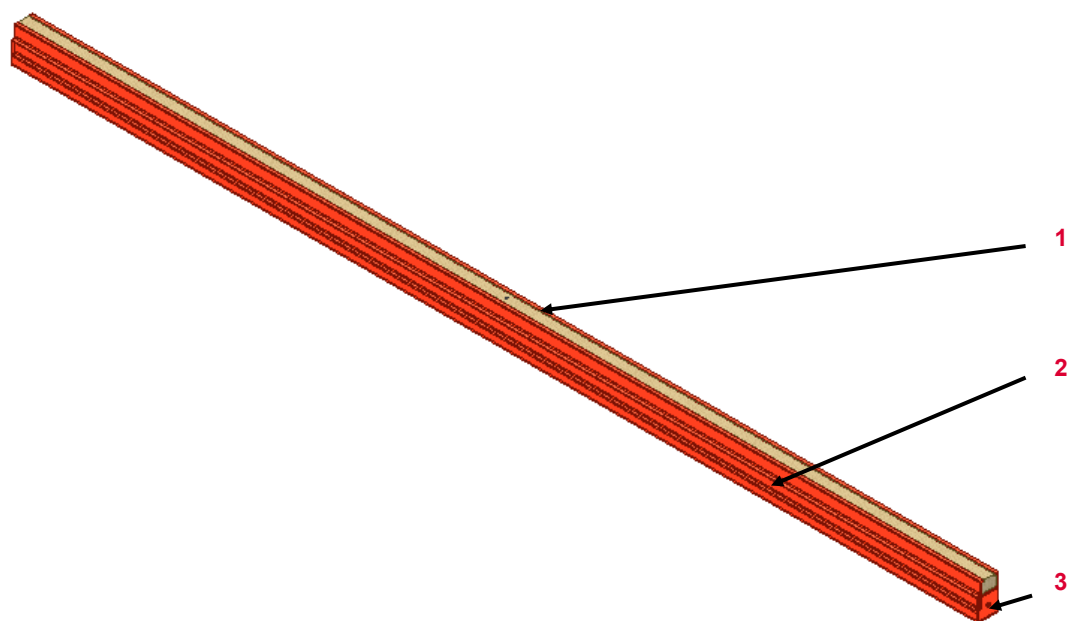

1	Dēlis	
2	Profils	
3	Nosegplātne	115673











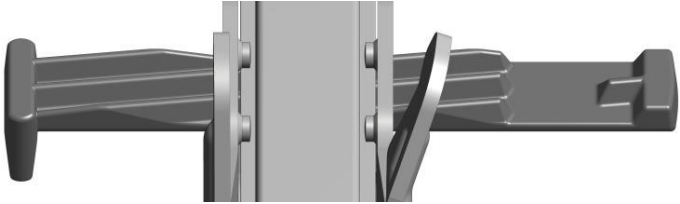



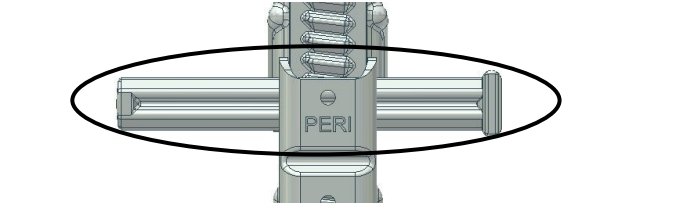

Attiecināms uz	Artikula Nr.
Profils TPP 120 Alu	101823
Profils TPP 270 Alu	101813
Profils TPP 330 Alu	101829

Profils TPP	Apraksts	Darbība	Izmaksas	Tips
	27.66 Nolietojies dēlis			
	27.67 Izliekts profils ■ > 8 mm			
	27.68 Caurums profilā ■ > 10 mm			
	27.69 Bojāta noseglātne			

PERI kvalitātes prasības

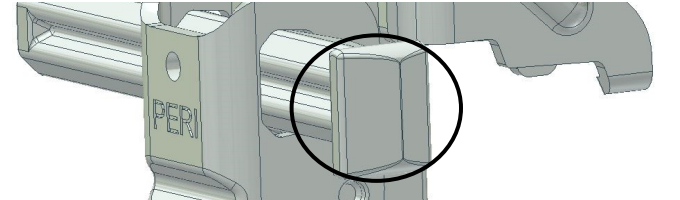
TRIO







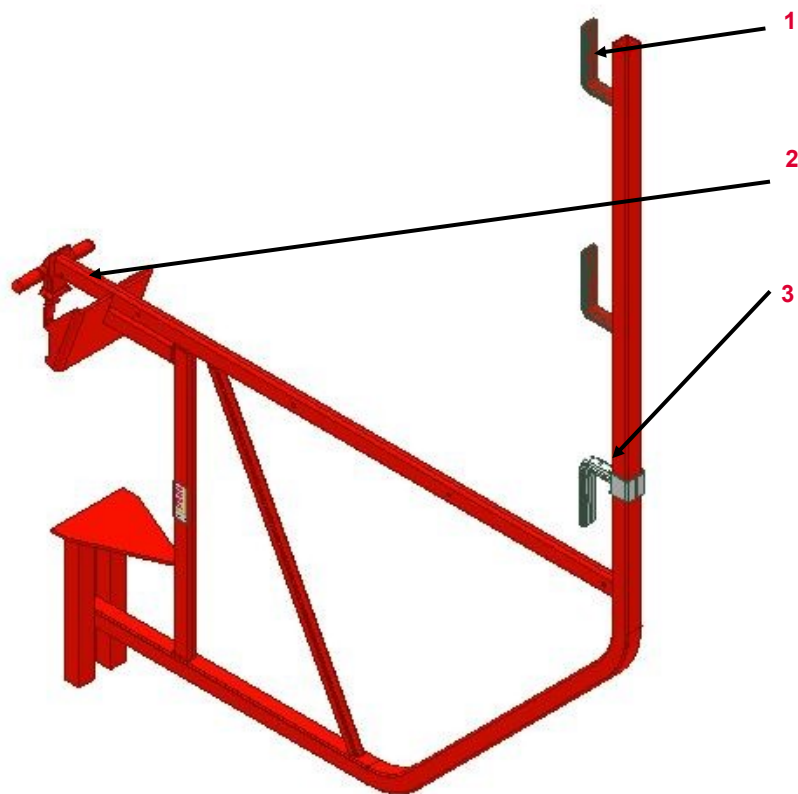









TRIO stiprinājums BFD (023500)	Apraksts	Darbība	Izmaksas	Tips
	27.70 Saliects savienojuma āķis		 088244	
	27.71 Savienojums sadalījies daļās		 088032	
	27.72 Ķīlis iesprūdis plaisa salliects			
	27.73 Plaisa uz sitiena virsmas			



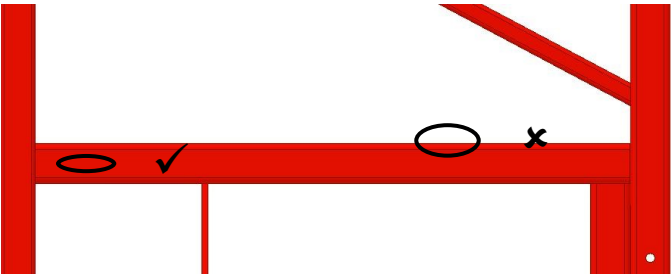









TRIO betonēšanas konsole TRG

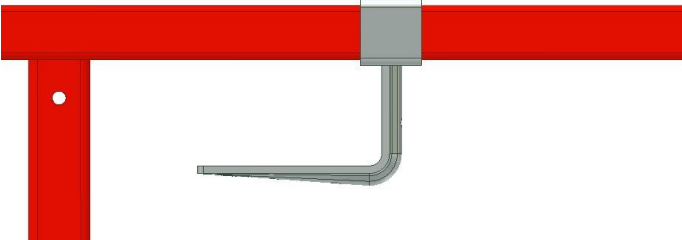

Nr.	Nosaukums	Artikula Nr.
1	Kronšteins	115543
2	Betonēšanas konsoles galva	
3	Slīdošais kronšteins	115673

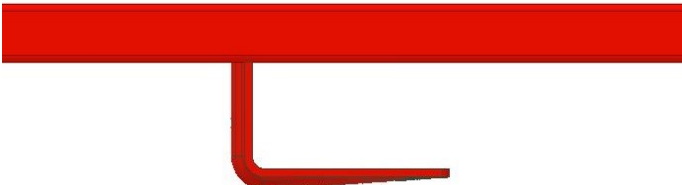
Attiecināms uz	Artikula Nr.
Betonēšanas konsole TRG 120	023680
Betonēšanas konsole TRG 80	023670

Betonēšanas konsole TRG	Apraksts	Darbība	Izmaksas	Tips
	27.74 Deformēta betonēšanas konsoles galva			
	27.75 Nepilnīga betonēšanas console, trūkst kronšteini			
	27.76 Bukte uz rāmja profila <ul style="list-style-type: none"> ■ Bukte rāmī, kants nav skarta ■ Bojāta rāmja kants 	 	 	 

Betonēšanas konsole TRG	Apraksts	Darbība	Izmaksas	Tips
	27.77 Plaisa metinājuma šuvē <ul style="list-style-type: none"> ■ Ar redzamiem rāmja bojājumiem ■ Bez redzamiem rāmja bojājumiem 	 	 	 
		27.78 Slīdošais kronšteins, bojāts trūkst	 115673	 088184
	27.79 Kronšteins bojāts trūkst		 088000	

Pildīšanas plātne LA

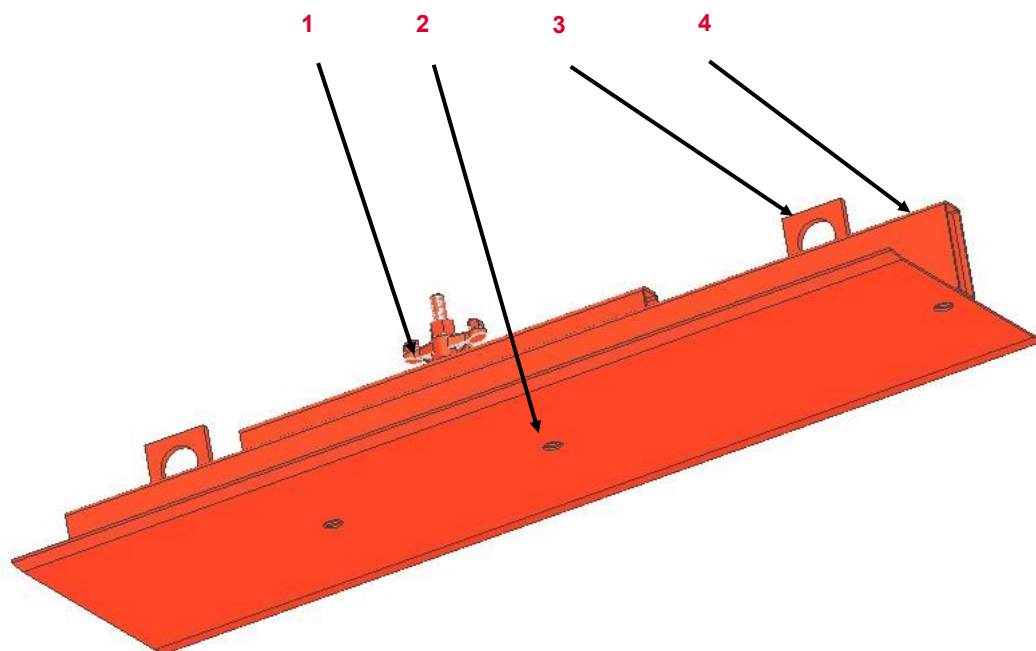

Nr.	Nosaukums	Artikula Nr.
1	Spārmuzgrieznis	030100
2	Betonēšanas virsma	
3	Plāksne	740514
4	Caurule	

Attiecināms uz	Artikula Nr.
Pildīšanas plātne LA/4 330x36	054384
Pildīšanas plātne LA 270x36	023170
Pildīšanas plātne LA 120x36	023270

PERI kvalitātes prasības

TRIO

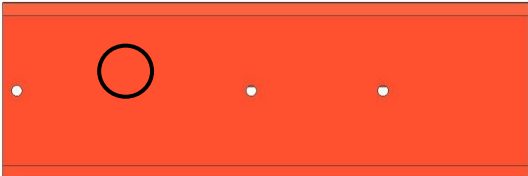

Pildīšanas plātne LA	Apraksts	Darbība	Izmaksas	Tips
	<p>Izliekts profils</p> <ul style="list-style-type: none"> ■ > 8 mm 			
	<p>Spārnuzgrieznis bojāts trūkst</p>			
	<p>Plāksne deformēta plaša</p>			
	<p>Bukte betonēšanas virsmā</p>			

PERI kvalitātes prasības

TRIO



Rīgelis	Nr.	Nosaukums	Artikula Nr.
---------	-----	-----------	--------------

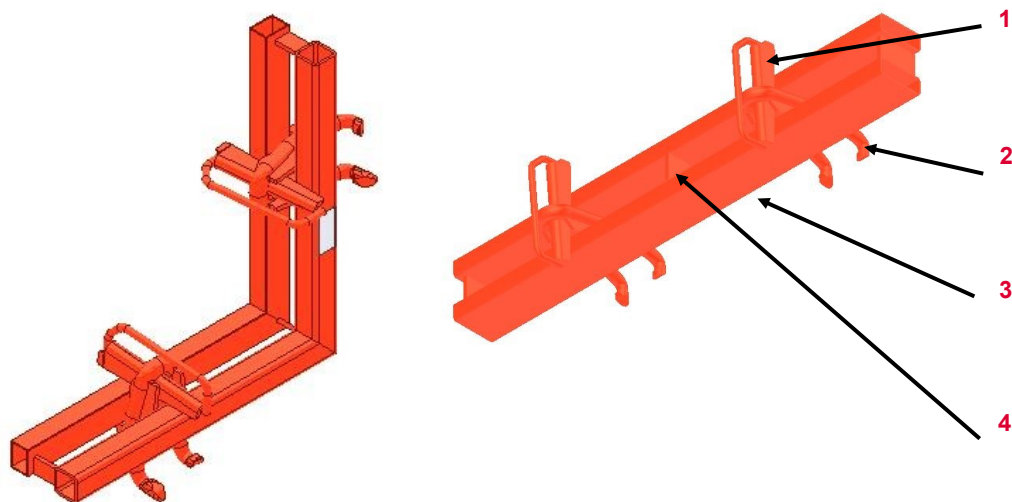

1	Ķīlis	750585
2	Āķis	751543
3	Profils	
4	Profils FI	













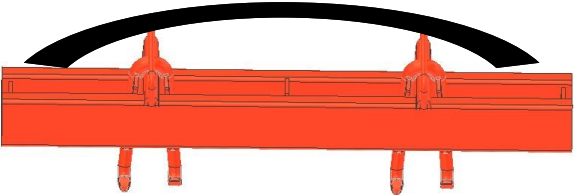

Valid for	Artikula Nr.
Rīgelis TAR 85	023550
Rīgelis 85	023551
Rīgelis TVR 45/45	023560

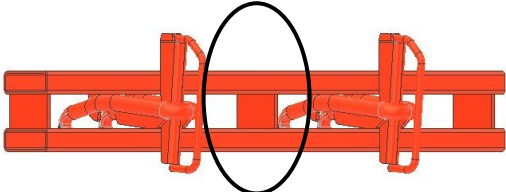

PERI kvalitātes prasības

TRIO



Rīgelis	Apraksts	Darbība	Izmaksas	Tips
	27.84 Bojāts āķis vai ķīlis	 751543 (TVR) 751544 (TAR) 750585 (abiem)	 088210 088209	
	27.85 Izliekts profils <ul style="list-style-type: none"> ■ > 5 mm līdz ≤ 10 mm ■ Vai > 10 mm 	 	 088244 	 
	27.86 Profils FI. trūkst			

Universālais rīģelis 245 (023920)	Apraksts	Darbība	Izmaksas	Tips
-----------------------------------	----------	---------	----------	------



27.87 Izliekums

■ > 8 mm

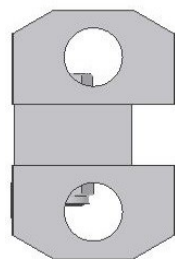

27.88 Nosegplāksne saliekta | trūkst



088155

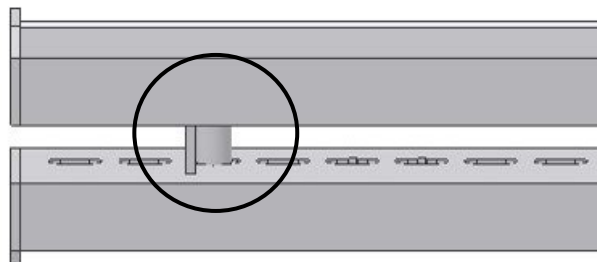

27.89 Trūkst starplika



104178 (starplika)
024910 (skrūve)
781053 (uzgrieznis)
024180 (paplāksne)



088211



TRIO RSS savienojums (023660)	Apraksts	Darbība	Izmaksas	Tips
-------------------------------	----------	---------	----------	------



27.90 Plaisa metinājuma šuvē



27.91 Bojāts, saliekts



088244



27.92 Bojāts spārnuzgrieznis



030190 (spārnuzgrieznis)



















088541

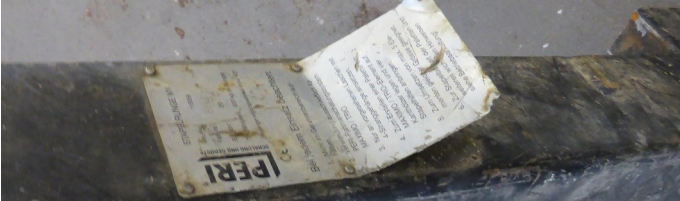









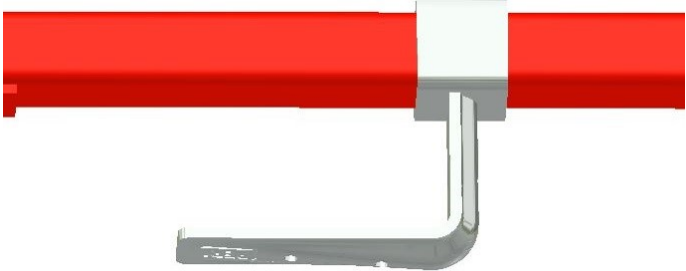



PERI kvalitātes prasības

TRIO



Kraušanas ierīce MX (115058)	Apraksts	Darbība	Izmaksas	Tips
	27.93 Saliiekts profils		 088244	
	27.94 Plaisa metinājuma šuvē	 		
	27.95 Marķējuma plāksne trūkst nesalasāma		 088037	
	27.96 Deformēta		 088244	

Margas stute HSGP-2 (116292)	Apraksts	Darbība	Izmaksas	Tips
	27.97 Slīdošais kronšteins deformēts iztrūkst	 115673	 088184	
	27.98 Kronšteins deformēts trūkst		 088000	
	27.99 Izliekts, deformēts ■ > 5 mm			

PERI kvalitātes prasības

TRIO



Stutes turētājs (101592)	Apraksts	Darbība	Izmaksas	Tips
--------------------------	----------	---------	----------	------

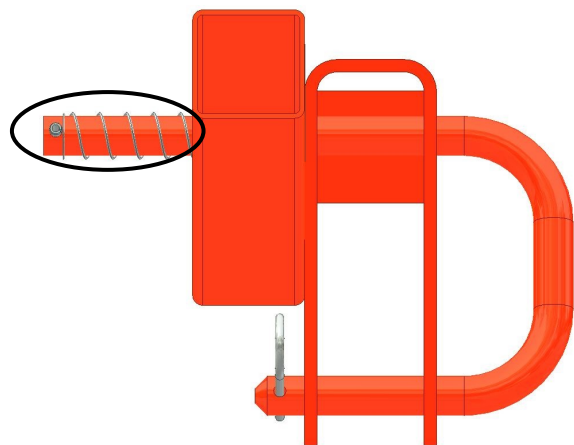

27.100 Nelietojama atspere



721816 (Atspere)

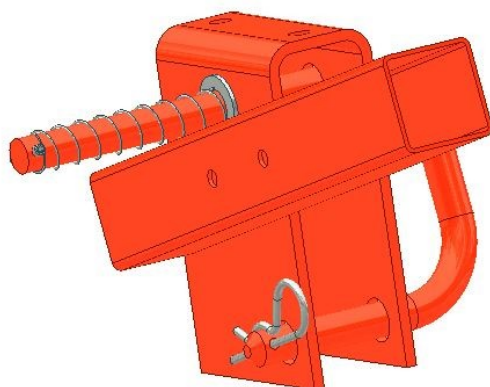

27.101 Salocīts



088244



PERI kvalitātes prasības

TRIO



TRIO pamatu savilcējs (023010)	Apraksts	Darbība	Izmaksas	Tips
--------------------------------	----------	---------	----------	------

27.102 bojāts uzgrieznis

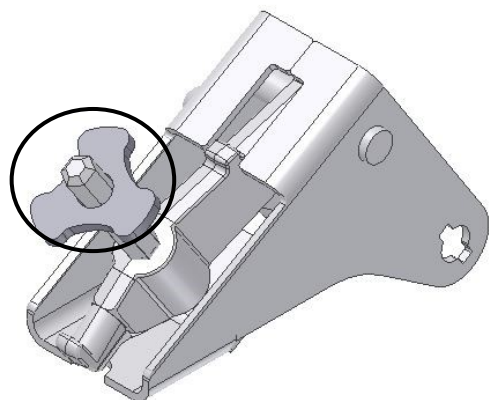

27.103 tapa deformēta | trūkst



722927 (Tapa)
722929 (Šķeltā tapa)



















088180



PERI kvalitātes prasības

Vārdnīca



Ikona	Nozīme	Ikona	Nozīme	Ikona	Nozīme
	Nav derīgs - materiāls jānoraksta		Jāizraksta rēķins (klientam)		Vizuāls bojājums
	Derīgs - materiāls paliek nomas parkā		Rēķins nav jāizraksta		Funkcionāls bojājums
	Norakstāms materiāls – izdošana nomā nav pieļaujama dēļ neatbilstības drošības prasībām		Saīsināt materiālu		Funkcionāls bojājums - izdošana nomā nav pieļaujama
	Remonts saskaņā ar instrukciju		Marķēt materiālu		Statisks bojājums - izdošana nomā nav pieļaujama
	Aukstā labošana – veicot metinājuma šuvju un blakus detaļu pēcpārbaudi		Nomainīt bojāto materiālu		
	Remonts tikai pēc izmaksu tāmes izvērtēšanas		Atvietot trūkstošo materiālu		
	Materiāla tīrīšana				